

NATIONAL INSULATOR ASSOCIATION



DRIP POINTS

Volume 12

Number 4

Summer 85'



NATIONAL INSULATOR ASSOCIATION
6980 WALNUT LK RD
WEST BLOOMFIELD MI 48033



TO:

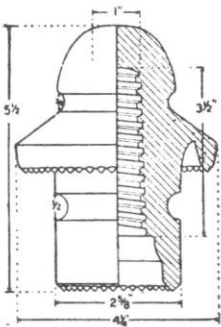

No. 51
(Old No. 1)

BERRY, ROBERT W JR.
NIA# 1203
RR# 1, BOX 345, SHELLY HILL RD
STANFORDVINE NY 12581

PRESIDENT

Michael Bruner NIA #1482
6980 Walnut Lake Road
West Bloomfield, MI 48033
(313) 661-2359

TREASURER

Rod Krupka NIA # 1308
2615 Echo Lane
Ortonville, MI 48462
(313) 627-6351

EXECUTIVE DIRECTOR

Kevin Lawless NIA #1679
41 Crestwood Drive
Schenectady, NY 12306
(518) 355-5688

INFORMATION DIRECTOR

Kenneth Stefan NIA #2413
2240 West Nichols; Apt. E
Arlington Heights, IL 60004
(312) 392-7185

EASTERN REGION VICE-PRESIDENT

John DeSousa NIA #419
5 Brownstone Road
East Granby, CT 06026
(203) 658-0353

CENTRAL REGION VICE-PRESIDENT

Dennis Weber NIA #1889
3609 Jackson
St. Joseph, MO 64507
(816) 364-1312

WESTERN REGION VICE-PRESIDENT

Violet Brown NIA #652
7049 243rd Avenue, NE
Redmond, WA 98052
(206) 885-4862

DRIP POINTS

PUBLISHED QUARTERLY BY

National Insulator Association



COPYRIGHT © 1985 by

NATIONAL INSULATOR ASSOCIATION

All rights reserved

FROM THE PRESIDENT:

Dear Members:

Well the 1985 National is now history. It was so great to see so many of you at St. Charles. It is a shame we can't get together like that every month!

I managed to add some nice things to my collection, and as usual, I bottomed out my finances. Oh well - What is a hobby for anyway?

My congratulations to our show hosts this year. I do believe this show was one of the most active in recent years, thanks in part to the advertising and railroad shows.

I'd like to introduce to you three new people on the NIA team:

DENNIS WEBER NIA #1889
Dennis is the new Central Region Vice-President.

CHRIS HEDGES NIA #15
Chris is now the NIA Historian.

RUSS HUGHES NIA #2859
Russ is now the new Nomination Committee Chairman.

These people are just super individuals, and I'm really looking forward to their assistance. Please give them your support.

I might mention that we have changed the wording of our by laws under the NIA special awards section. Actually we only changed one word. If you look in your handbook on page 20, section VI, the first sentence will now read:

"The National Insulator Association may at each Annual National Convention show present three special NIA awards as follows:"

This change was made to insure that we give these honors to those individuals that have clearly demonstrated the outstanding qualifications needed for each particular award.

Our treasurer, Rod Krupka, is in England as I write this so I have to inform you members that were not in attendance at the general membership meeting on Friday, June 7th, that those members who were present, by recommendation of the NIA board, voted to raise the annual dues to \$8.00 per year. No other changes were made at this time in the dues schedule. The new membership fee will become effective April 6th, 1986.

If fewer than 5 percent of the current NIA membership gives written objection to the proposed amendment, within 90 days of the mailing of this issue, then the new annual fee shall be ratified. Direct any letters to me personally. My address is on the inside of the front cover.

And speaking of dues, Rod asked me to remind you that if you have not renewed yet, to do so now. We have computer generated the mailing list, so if your mailing label is any other color than white, your membership has expired as of April 1st 1985 (4 months ago!), and this will be your last issue of DRIP POINTS.

We need this money to cover postage costs, not to mention all the other things the NIA uses your membership dues for. So please, if you have not renewed, I urge you to do it now! You will find a membership renewal application enclosed in this issue of DRIP POINTS.

Also, I'd like each of you to check your address label for errors. If there are any misspellings or corrections that need to be made, please write me with the correct information.

Well, let me just say how proud I am of all of you - and this great hobby too. I feel that my first year as NIA president was a busy one, with shows to attend, business to transact, a computer to load, and all the other things that have to be done. But it has been a great year and a time in my life that I'll always cherish. You people have made this hobby great. Hopefully I'll always be collecting, but more important, I want to always be with the many friends that I have made through out the years.

Keep in touch,

Michael Bruner

NIA #1482

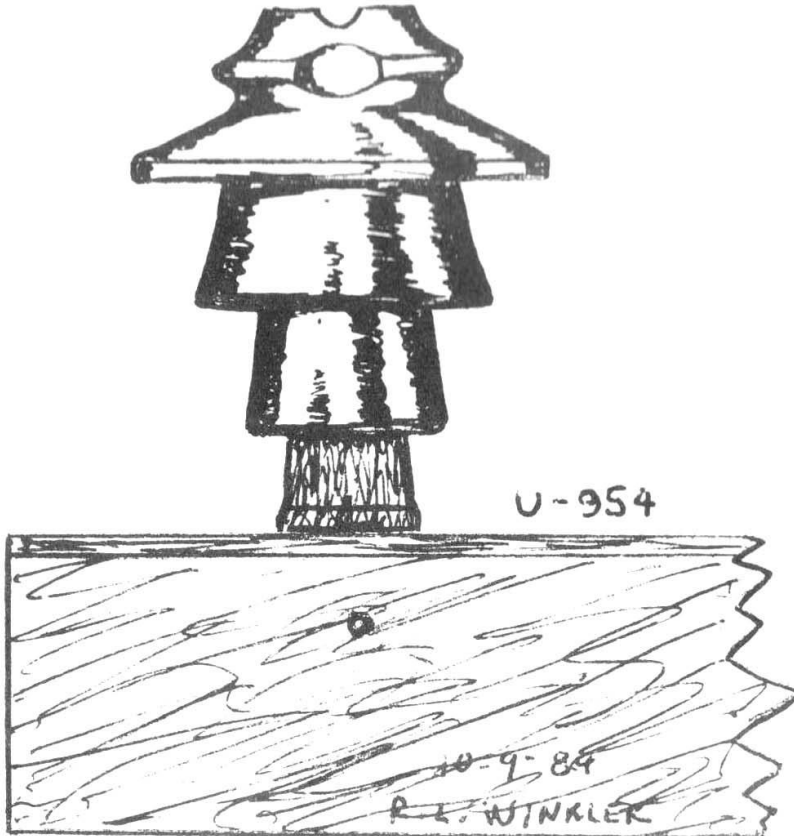

FROM THE INFORMATION DIRECTOR:

Hi and welcome to yet another issue of DRIP POINTS.

The excitement has finally wound down from the National. My compliments to the show hosts; Jim Crandall, Mike Sovereign, and Larry Veneziano, who did an excellent job on presenting this years show. It takes an awful lot of effort, hard work, and dedication to put on a show of this size. Nice job guys!

As Mike had mentioned in his contribution, we have three new additions to the NIA Board. I feel that the three members leaving the NIA Board should be commended for their fine efforts; Mike Sovereign - Central Region Vice-President, Mel Shootman - Nomination Committee Chairman, and Carol McDougald - NIA Historian. I'm sure I can speak for all NIA members to thank these fine people for all their time that they have donated to the NIA.

Have a good summer!

Sincerely,

Mel Shootman

NIA #2413

33 KV

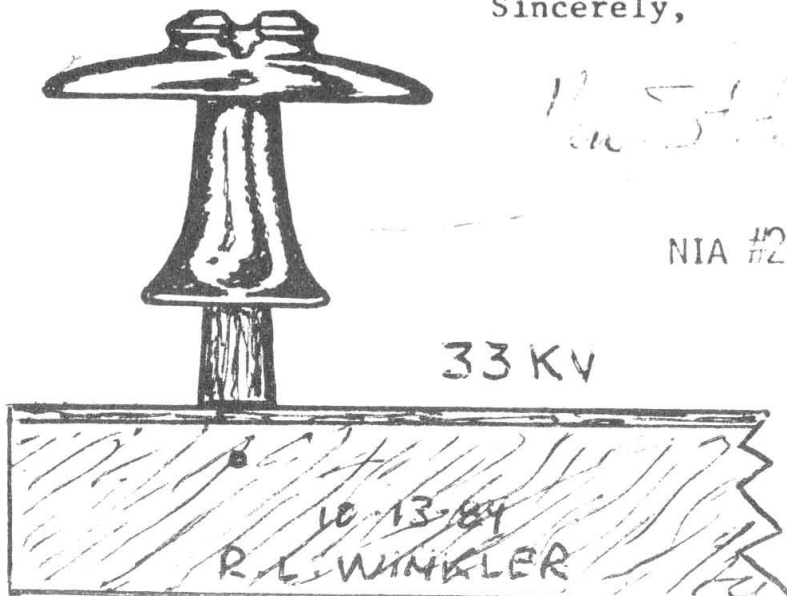

FROM THE EXECUTIVE DIRECTOR:

Dear Fellow NIA Members:

It has been a while since you last heard from me, since I missed the deadline for the last Drip Points! However, I will not make up for it with a double column.

I was very pleased to see many of you at the St. Charles National last weekend, which was a fine show and featured lots of great glass. (It was a trifle warm on Saturday.) Those of you that missed this year's show - shame on you! We will see you at next year's National.

Speaking on next year's National, it is my great pleasure to announce that it will be held in Saratoga Springs, New York, on July 11-13, 1986. I am pleased to co-host this show with John DeSousa and Doug MacGillvary and we promise to bring the hobby its biggest show, yet! Keep reading in Drip Points, "Crown Jewels of the Wire" and "Antique Bottle and Glass Collector" for further information! The NIA Board of Directors has also approved Enumclaw, Washington as the location for the 1986 Western Regional Show. Violet and Andy Brown will host this show. A Central Regional Show will be approved and announced in the next Drip Points.

On a sad note, the insulator-collecting hobby lost a fine member on May 11. My good friend, Sterling Finch, of Scotia, New York, passed away after a short illness. He was 70 years old. Many from the Northeast knew Sterling very well, since he was a strong supporter of

the Capital District and Yankee Polecat Insulator Clubs, as well as the National Bottle Museum Society. He was also a charter member of the NIA. Sterling will be sorely missed by his many friends.

I think it is important to realize that the act of collecting in itself is just a small part of a hobby. It takes people to talk and get together before any hobby can be successful, and I think that we have a very successful hobby, in terms of people involvement. In this past year alone, we have lost five charter members of our organization, and each contributed in thier own way to the development of our hobby. So, instead of a moment to memorialize, I would like to offer my thanks to our departed friends; Gerald Brown, Gert Wyer, Rip West, Ruby Bryant, and Sterling Finch for brightening our hobby and our lives.

In the next issue of Drip Points, I will have the minutes of this year's NIA general meeting. In the meantime, support the following shows, or your local show, since your show host has spent a lot of time and money for your hobby's benefit.

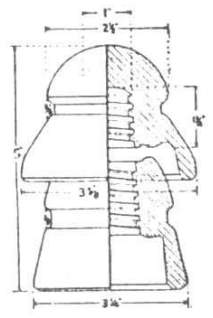

No. 50

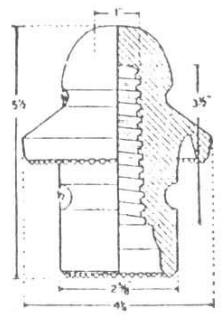

No. 51
(Old No. 1)

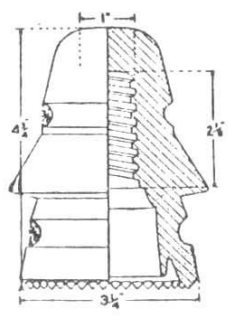

No. 52
(Old No. 2)

August 3 Auburn, CA (Nor-Cal Insulator Club)
September 28-29 Kulpsville, PA (Eastern Regional)
October 12-13 Bakersfield, CA (Western Regional)
October 13 Keene, NH (Yankee Bottle Club)
October 20 Albany, NY (Capital Dist. Ins. Club)

Good Collecting,

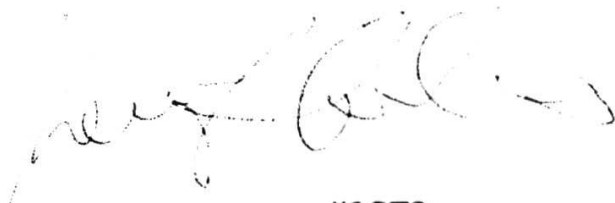

NIA #1679

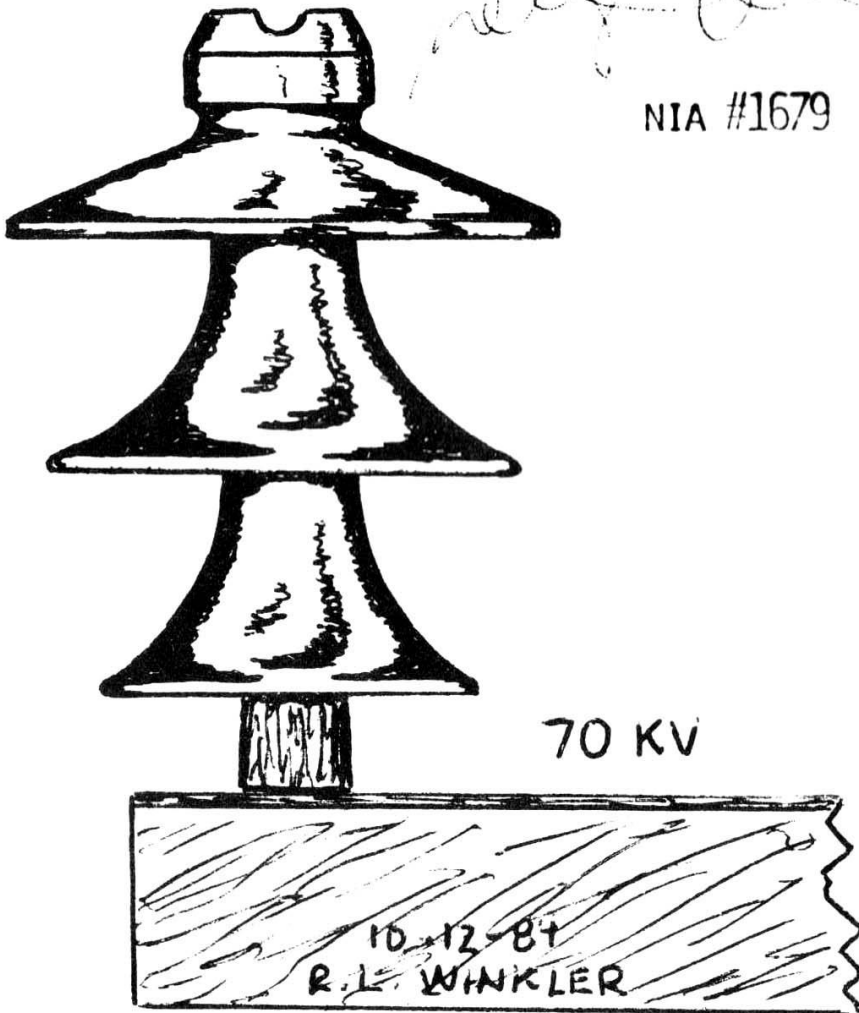

FROM THE EASTERN REGION VICE-PRESIDENT:

With all the excitement of the National in St. Charles just dying down, I really don't have too much to report.

The Yankee Pole Cat Insulator Club had its Spring Show and Sale on April 14th and it was well attended. The Club recruited new members bringing the membership total to well over seventy. Larry Emons drove his mobile display on the back of his antique Ford Model A pick up truck which was the highlight of the day.

The Sixteenth Annual Genesee Valley Bottle Collectors Association Bottle and Advertising Show and Sale in Rochester, NY on April 28th was well supported by both Eastern and Central Region Collectors. Trading and buying was strong throughout the day.

Eastern finds are still here! A clear lightning rod insulator embossed "LYONS" was found in Massachusetts. In a New York flea market a NY & EIRR threadless hat was purchased for \$5.00.

The NIA Eastern Region will be in Kulpsville, Pennsylvania on September 28th and 29th, hosted by Claude Wambold and Steve Bobb. The show will be at the Towamencin Fire Company Social Hall, Exit 31, off the Pennsylvania Turnpike (Route 9), in a well lighted hall on ground level. It is within walking distance of the Holiday Inn complex and the Budget Valley Motel and Restaurant.

Claude told me that if you come a day early to the area, you might want to stop in Kutztown, on September 27th at Renninger's Antique and Flea Market as there is a Fall extravaganza with over 1200 dealers. Also, within thirty miles of the

show site, are the Liberty Bell and Independence Hall in Philadelphia and Valley Forge National Park at Valley Forge. Hope to see you all there. For details, call or write to Claude Wambold or Steve Bobb.

Good Collecting,



John de Sousa

NIA #419

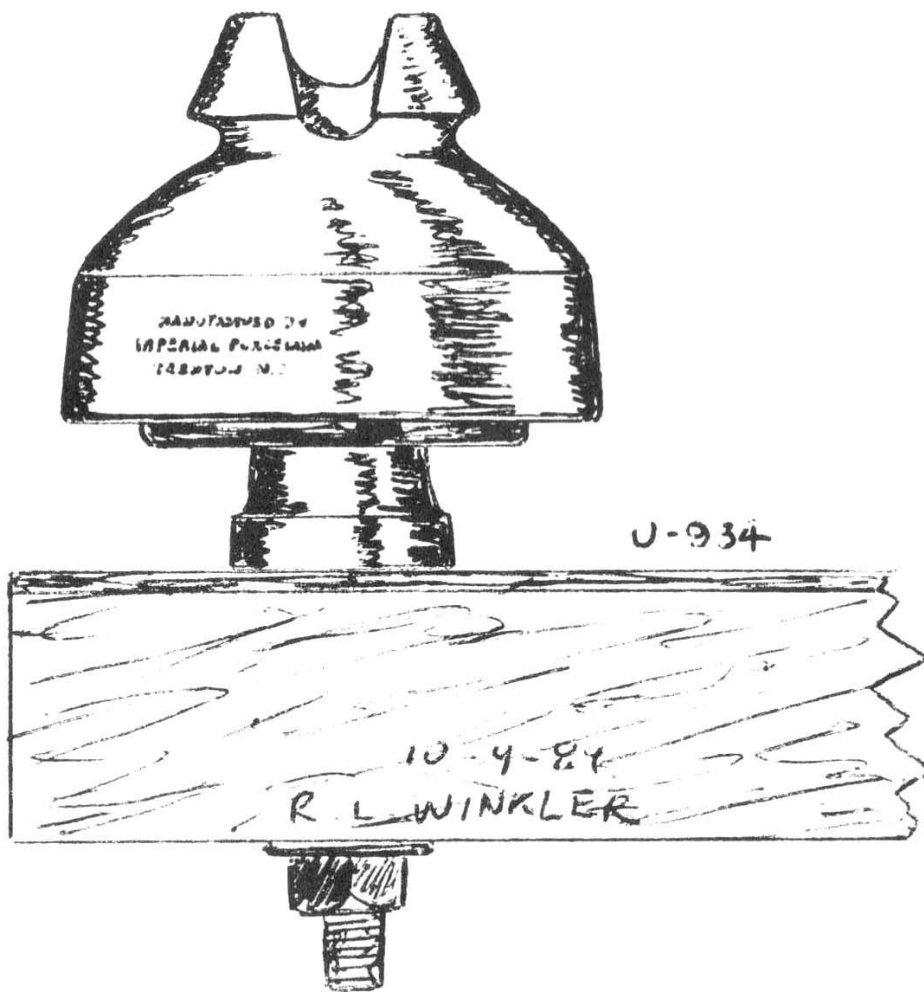

FROM THE CENTRAL REGION VICE-PRESIDENT:

As the new Central Region Vice-President, I would like to thank all of those who took time to send in their votes.

My wife Jeanne and I just arrived home after a short vacation to Ohio and Pennsylvania, following the National, and are now getting ready to go up to Cedar Rapids, IA to the Antique and Collectables Show and Sale, presented by the Iowa Antique Bottleers and hosted by Larry Whitlock. Of course there are plenty of insulators there, so I hope to see some of you insulator collectors there. Larry has done a fine job over the years of organizing this show and needs your continued support. As you know, Larry put on a fine National back in 1982.

And speaking of Nationals, we sure had a great one this year. Anyone who missed this one, missed one of the greatest ever. I want to thank the hosts - Mike Sovereign, Jim Crandall and Larry Veneziano for doing a fine job. I came home a little poorer, as usual, but had a great time and wouldn't have missed this one for the world.

By the way, we still don't have a host for the Central Regional for 1986 as I write this letter. Anyone interested, please contact Kevin Lawless, our Executive Director, as soon as possible. Come on guys, lets get those bids in.

If anyone has any problems, complaints, or just some ideas, please contact me. That's why I took this job. Lets hear some chatter.

Sincerely,



NIA #1889

FROM THE WESTERN REGION VICE-PRESIDENT:

We were sorry not to be able to attend the National in St. Charles this year. I hear it was a good show, with lots of good glass and that railroad item collectors had a ball.

The Enumclaw show this year, was a sell out, and for those who may not know it, we will be hosting the 1986 Western Regional Show. This will be held at the fairgrounds in Enumclaw on May 3rd and 4th. We're hoping to make this one of the biggest and best shows ever and invite all to attend.

Later this summer, we will be driving to Alaska to visit our two daughters and other relatives. As soon as we arrive I'll put an ad in the local paper for insulators and some of the other things we collect. The response is usually quite good (it is amazing how many Hemi 42's and Whithall Tatum - clear or aqua - that there are), but we usually find a few good ones to bring home. Some nice finds have been a nice Cal. Electric, green Mickey, cobalts, Californias and carnivals. This reminds me of the carnival glass still in use in Fairbanks (I think they are CD-325 or 326). It was quite a sight to see these beautiful pieces with the sun shining on them!

We stop at all antique and junk shops along the way of course, and have found a nice purple Braille in British Columbia. Speaking of Canada, we've been going to some shows and flea markets just over the border. Some have really good buys, at times, and with the money exchange being so much in favor right now (\$35 per \$100) it is a big advantage. For all our Canadian friends, however, it makes it really bad, since their dollar is worth so little down here. I for one will be glad to see the money exchange more even.

I hope to see you all at our annual summer-time insulator collector's tailgater/campout at Snoqualmie Pass.

Walter Brown

NIA #652

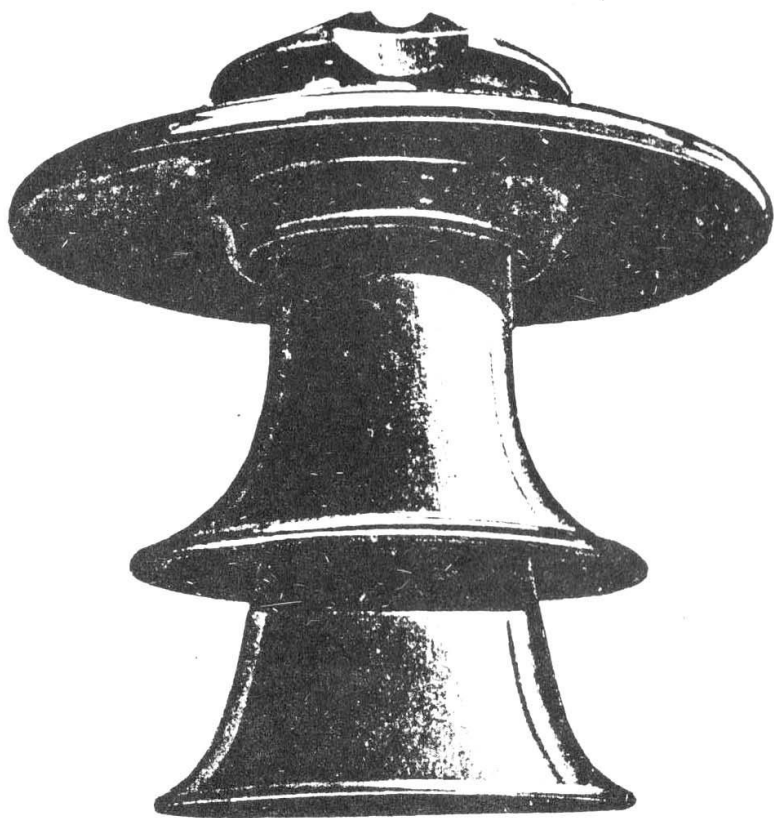

No. 14 "C-T."

FROM THE SHOW STANDARDS CHAIRMAN:

Hello to everyone in insulatorland. Another fantastic National swap meet is now history. Did you have the pleasure of attending? If so, I hope the show was as enjoyable for you as it was for me. My sincerest compliments to our trio of sponsors - I think you did an outstanding job.

If I had to single out one specific aspect of the show which impressed me the most, it would definitely be the re-appearance of several old timer dealer/collectors. This group includes such individuals as Tom McGill, Rodney Wing, John Slagle and Rich Sharer. We have seen very little of these men during the past six to eight years, and it was really great seeing them again. Collectively, they have at least eighty years of involvement in our hobby, and for the sake of our hobby, we need to see them more often in the future. They contribute significantly to the success of any show, merely by their presence, and I for one hope they had a good time, and will continue their involvement.

I wish you all a safe and happy summer.

Best of luck,

Charlie Allum

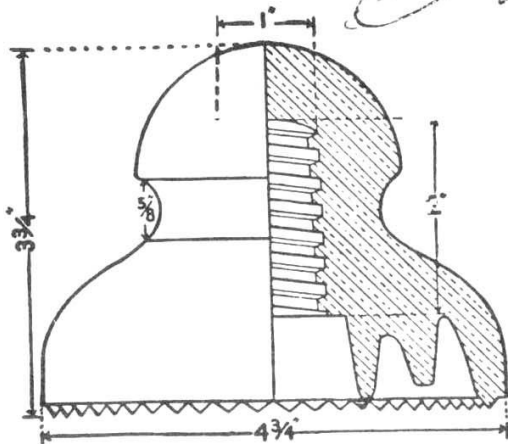

No. 71
(Old No. 1)

NIA #2814



FROM THE NOMINATION COMMITTEE CHAIRMAN:

My name is Russ Hughes and I have been involved with the insulator hobby for four years. During these four years I have met numerous people and have learned much from them concerning insulators, and because of this, in 1984, I formed the "Colorado Insulator Club" to help promote the insulator hobby here in Colorado and the surrounding region.

Serving as Nomination Committee Chairman I will look forward to hearing from you, the members of the NIA, on any input or suggestions that you might have to further better our hobby. I want to thank the members of the NIA Board on their approval of my appointment to this position.

Sincerely,

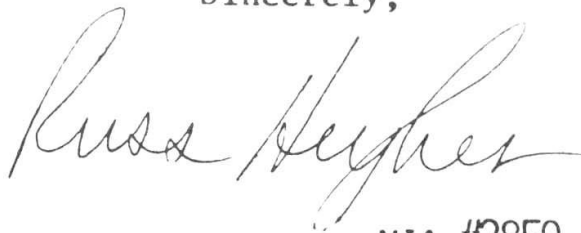

NIA #2859

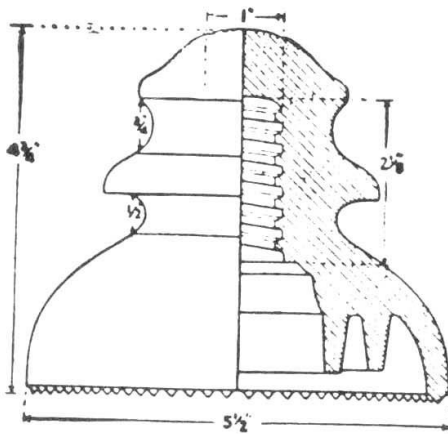

No. 73
(Old No. 2)

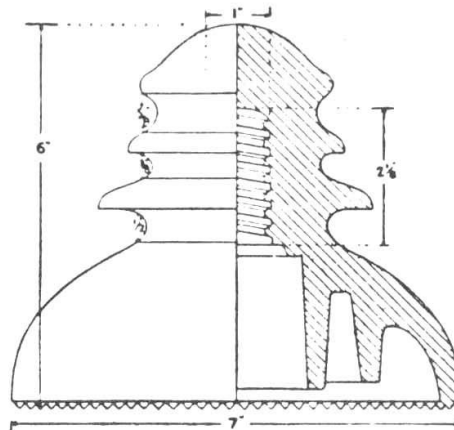

No. 74
(Old No. 1)

MORE FROM THE PRESIDENT:

I have just received this letter from Keith Neal of Guernsey and I would very much like to share it with the rest of you NIA members.

TO THE PRESIDENT AND BOARD OF DIRECTORS OF THE
NATIONAL INSULATOR ASSOCIATION:

Dear Michael,

Your wonderful letter and the Special Award came to me as a delightful surprise. I am touched beyond words at the generosity and kindness of all; a token of friendship that I shall value all my life.

If any contribution I have been able to make has given pleasure to others who share our very special hobby, this makes me happiest of all, and I can tell you in all truthfulness, that nothing during my lifelong interest in insulators can equal for me your gesture from the NIA. You have made me a very happy man. I say thank you from the bottom of my heart. I am proud to be a member of the NIA.

May your association continue to flourish.

Sincerely,

(Keith)

(Dated July 10, 1985)



Keep in touch,

Mike

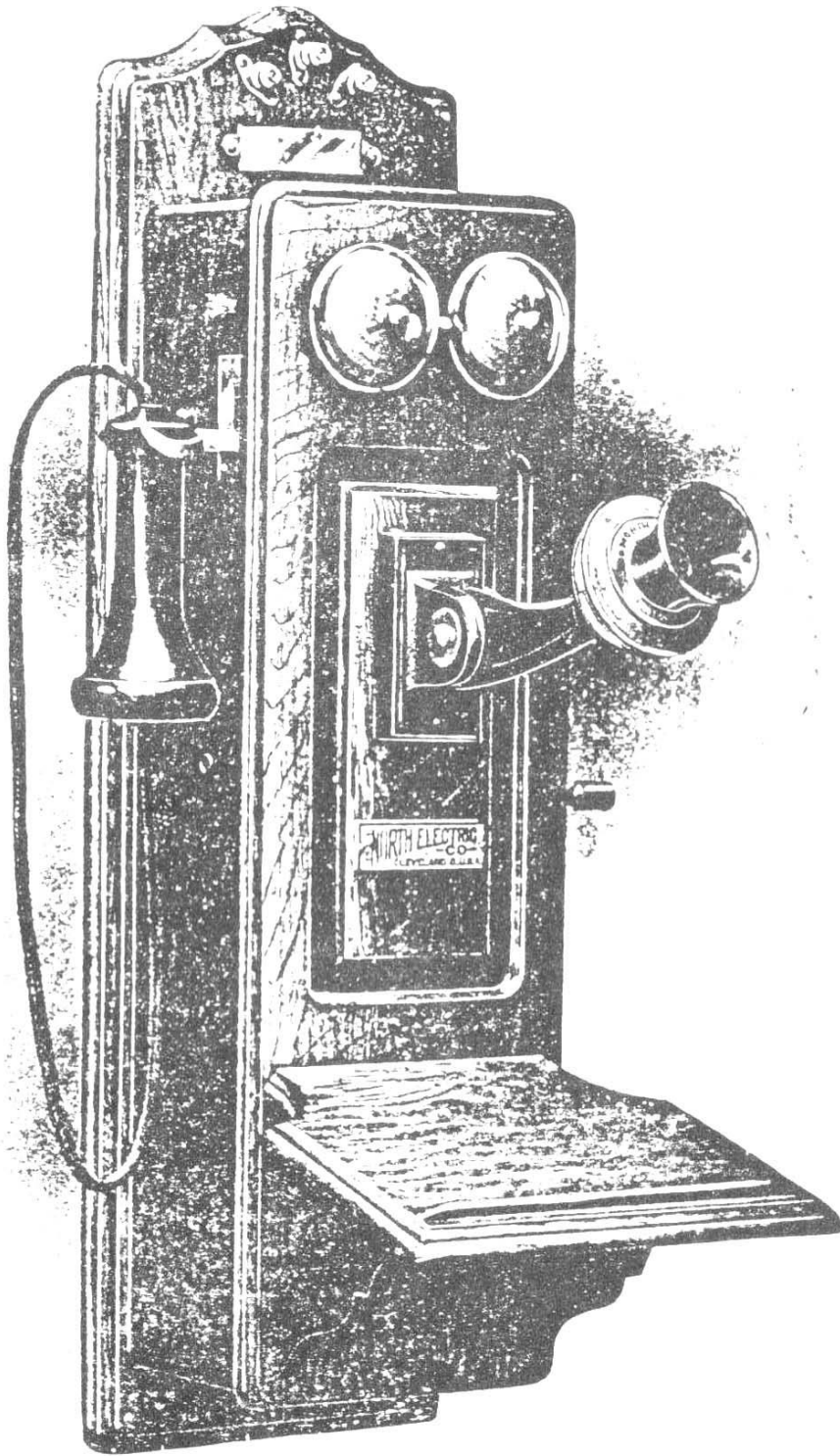

RURAL TELEPHONE TYPE K
North Electric Co.

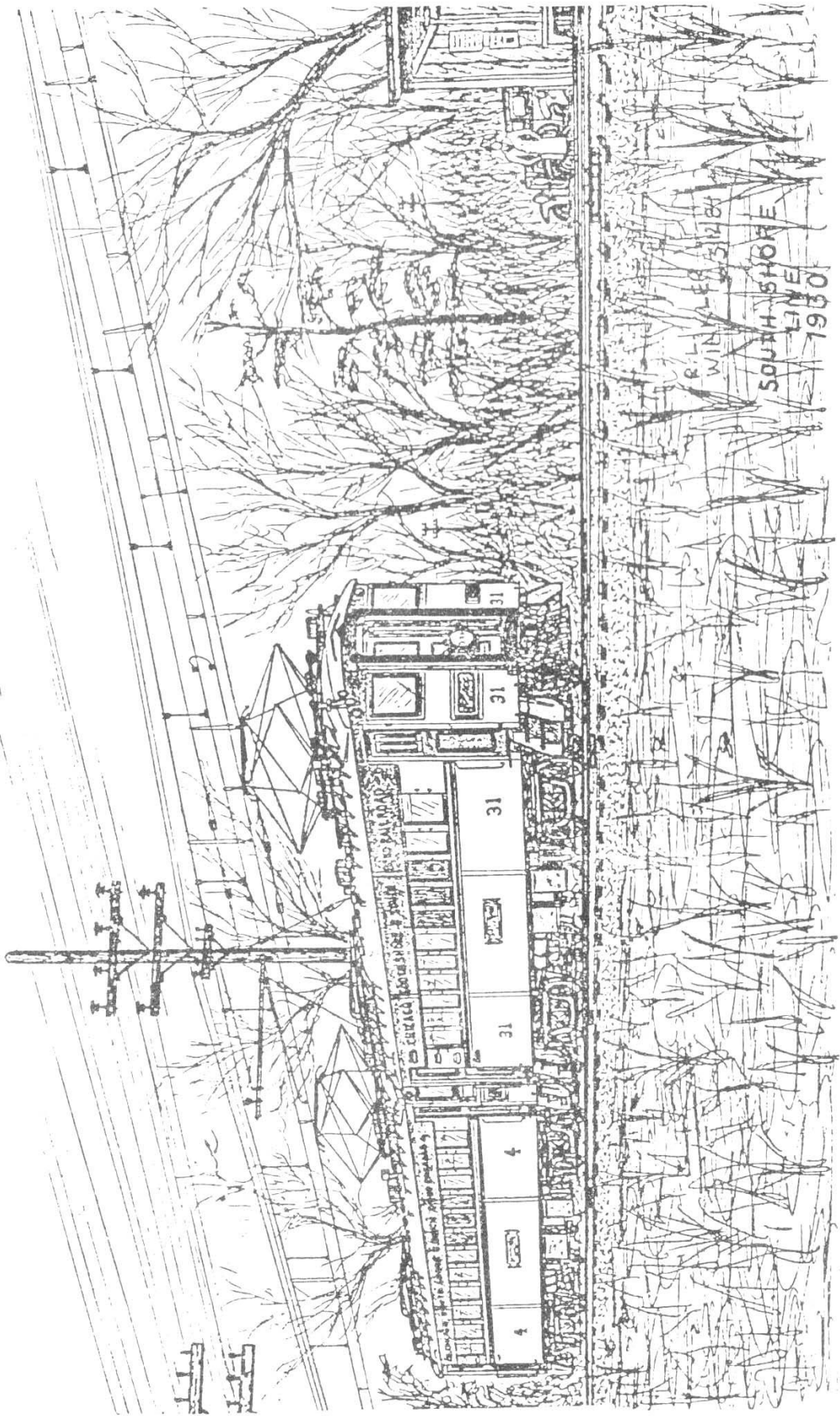

NATIONAL INSULATOR ASSOCIATION

INFORMATION ON N.I.A. MEMBERSHIP



The Fiscal year for membership dues starts and ends on March 31. The current dues amounts for various membership classes are:

- \$6.00 Adult (Regular individual membership)
- \$6.00 Family (This type of membership is for one voting adult and other family members at the same address. Enclose an additional \$1.00 for each family member who wishes voting privileges.)
- \$1.00 Junior (Under 18 years of age)

Make checks payable to "National Insulator Association" and send to: National Insulator Association, c/o Treasurer Rod Krupka, 2615 Echo Lane, Ortonville, MI 48462 (313-627-6351).

Each member, if not a subscriber to the magazine "Insulators--Crown Jewels of the Wire", will receive a copy of the March issue of that publication which serves as the name-and-address directory of all NIA members. Subject to the availability of March copies, new members may have to await the succeeding March directory issue.

New members are entitled to all membership privileges immediately upon payment of current dues. Regular and Junior members receive all NIA mailings including the quarterly newsletter, membership directory and membership handbook. Family members do not receive duplicates of these mailings to the same address, but do receive the membership card.

A current membership allows a member to display and purchase a sales table at NIA National Conventions and assures admittance to the show on the first day, Friday, which is limited to NIA members only.

I (we) apply for () New Membership () Renewal Membership in the National Insulator Association.

NIA # (If Renewal)

Name _____ # _____

Street _____ Phone _____

City _____ State _____ Zip _____

Family Members: _____ # _____

_____ # _____

_____ # _____

_____ # _____

_____ # _____

Date _____

Amount Enclosed \$ _____

IMMEDIATE PAST PRESIDENT

Marilyn Albers NIA #541
14715 Oak Bend Drive
Houston, TX 77079
(713) 497-4146

SECOND PAST PRESIDENT

Pat Patocka NIA #140
P.O. Box 326
Penryn, CA 95663
(916) 663-3681

ETHICS CHAIRMAN

John McDougald NIA #689
26812 John Road
Olmsted Township, OH 44138
(216) 235-2595

SHOW STANDARDS CHAIRMAN

Charlie Allmon NIA # 2814
1200 W. 76th Street
Kansas City, MO 64114
(816) 333-6727

NOMINATION COMMITTEE CHAIRMAN

Russ Hughes NIA #2859
2569 South Vrain Street
Denver, CO 80219
(303) 922-7733

HISTORIAN

Christopher Hedges NIA #15
P.O. Box 10378
Kansas City, MO 64111
(816) 753-0921

AUTHENTICATION COMMITTEE

Ray Klingensmith NIA #1654
709 Route 232
East Orwell, OH 44034
(216) 422-3326