

# CROSS ARMS

an  
insulator collectors'  
magazine

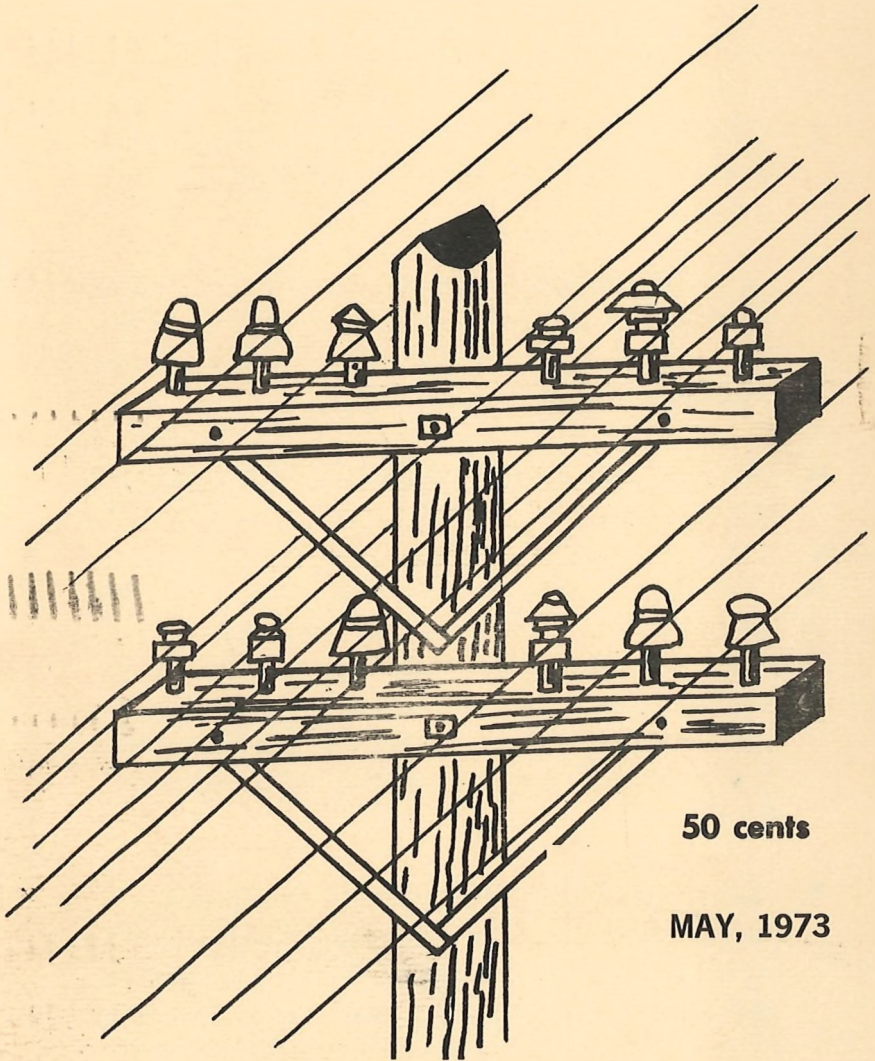

50 cents

MAY, 1973

367 Signal Hill Road  
King of Prussia, Pa. 19406

CROSS ARMS--dedicated to enriching the knowledge of the insulator collector, and enlarging the ranks of the insulator collecting hobby.

### PUBLISHING POLICY

1. CROSS ARMS will publish any information available concerning insulator shows and swap meets.
2. Any information received by CROSS ARMS before the 15th of the month will be published and in the hands of our subscribers by the 5th of the next month.
3. All ads are kept confidential until they are published.
4. We will do our best to make sure all advertisers are reliable but cannot be held responsible for the validity of their copy nor for their performance. We accept no responsibility for errors except to reprint the incorrect portion of the ad in a later edition.
5. Send black and white prints or copies as they will reproduce with more satisfactory results. All material will be returned to the sender if specified, all other material becomes the property of CROSS ARMS.

# CROSS ARMS

An Insulator  
Collector's Magazine

Vol. 2, No. 4

May, 1973

Editor James Garrity  
Production Catherine, Mary Alice Garrity, Edward  
Szymala

Single Copy 50¢. Subscription price \$5.00 (12 issues)  
Back issues available at 50¢ each. (Feb. '72 not avail-  
able).

Copyright © 1973 by CROSS ARMS  
This journal is protected by copyright and no part of it  
may be reproduced in any manner without written per-  
mission from the publisher.

## TABLE OF CONTENTS

	PAGE
CD of the Month (734)	24
Classified Ads	36
Eastern Insulator Club	19
Fresno, CA Show	34
Glass Capitol Show	17
History of the Ramshorn	30
Ithaca, New York Show	31
Letters to the Editor	9
Market News	23
Mormon Wade	27
M. T. Bottle Show	15
Patent Information	10
Shows and Swaps	2
Title Page	1
Western Half of the Transcontinental Tel.	20
Next month instead of our CD we will feature the Western Union Family Tree.	

## SHOWS AND SWAPS

### MAY 6- Bettendorf, Iowa

2nd Mississippi Valley Insulator Swap Meet, Holiday Inn, Middle Road at I-74 (Exit 2). Info: Dennis McHenry, Trexend, Rt. 1, Bettendorf, IA 52722.

### MAY 12-13- El Paso, Texas

El Paso Centennial Collectors Show at the National Guard Armory. Info: Bob Keyes, 1032 Burgess, El Paso, TX. 79909 Ph. (915) 598-2312. See classified ad section.

### MAY 12-13- Hutchinson, Kansas

Insulator, Lightning Rod Ball & Bottle & Collectibles Show, Sports Arena. Info: George Phillips, Box 1791, Hutchinson, KS.

### MAY 13-Middletown, New York

The 1973 Insulator Show & Trade Meet will be held at the Fancher Davidge Park. Info: B. S. Enterprises, 40 Lafayette Ave., Middletown, NY 10940.

### MAY 19- Westerville, Ohio

Mid-West Insulator Swap & Show will be held at the Grange Hall, 15 miles N. E. of Columbus, off I. S. 270. Info: Don Bauman, 6706 Charles Rd., Westerville, OH 43081.

### MAY 26- Moorestown, New Jersey

1st annual Southern New Jersey Insulator Meet at the High School. Info: Gene Bond, Jr., 15 E. Camden Ave., Moorestown, NJ 08057.



JUNE 2-3- Independence, Missouri

The Missouri barbed wire Assoc. invites insulator collectors to a show in Independence, MO. Info: Piper Wrigley V.P., 2404 Harvard, Independence, MO 64052 or Marie K. Gordon, 411 E. Kansas, Independence, MO 64050.

JUNE 9-10- Fort Scott, Kansas

3rd annual insulator, lightning rod ball, barb wire & related items, Fairgrounds 22nd & Horton St. Info: Paul Schroadter, 912 S. Margrove, KS 66701.

JUNE 9-10- Dos Palos, California

3rd Annual Insulator Swap Meet at Del Hale Hall, 931 Center St. Info: Charles Zuspan, P.O. Box 716, Dos Palos, CA 93620.

JUNE 9-10- Dearborn, Michigan

Metropolitan Detroit Bottle Club, Bottle Show & Sale at the Dear Born Sports Arena, 14900 Ford Rd. There will be insulators and lightning rod balls. Info: L. W. Promotions, Box #69, Gas City, IN 46933.

JUNE 10- Carlisle, Pennsylvania

1st Pennsylvania Insulator Show at the Quality Inn. 2 miles north on Rt. 11 off Exit #16 on PA Turnpike. Easy access from I-81 & I-83. 15 minutes from Harrisburg. Info: Ed Szymala, J-137 Belmont Plaza Apts., King of Prussia, PA 19406 (215) 265-6679.

JUNE 23-24- Sacramento, California

Central Valley Collectors Fair, 1600 Exposition Blvd., Cal Expo. Bottles, insulators, Avons, stamps, and all collectibles. Info: Joanne Berry, P.O. Box 941, Citrus Heights, CA 95610.

JULY 7-8- Hutchinson, Kansas

4th National Insulator Show, Sports Arena. Info: Thomas D. Wolfe, Box 190, Auburn, NB 68305 or George Phillips, Box 1791, Hutchinson, KS 67501.

JULY 14-15- Redwood Acres, Eureka

8th Annual Humboldt Antique Bottle Collectors Show & Sale, (Bottles, Insulators, Relics). Info: P.O. Box 6012, Eureka, CA 95501 (707) 442-8726.

AUGUST 25-26- Denver, Colorado

Mountain States Insulator, Bottle and Collectibles Show & Sale. Info: Michael Bliss, 4640 E. Asbury Circle #22, Denver, CO 80222.

SEPTEMBER 1-2- Hutchinson, Kansas

Insulator, Lightning Rod Ball & Bottle and Collectors Show, Sports Arena. Info: George Phillips, Box 1791 Hutchinson, KS 67501.

SEPTEMBER 1-2-3- Bakersfield, California

2nd Annual Insulator Show at Bakersfield Elks Lodge Hall. Info: Chuck Henry, 7400 Pembroke Ave., Bakersfield, CA 93308.

SEPTEMBER 9- Alexander. New York

Western New York Bottle Collectors Sale. Insulators Lightning Rod Balls & Bottles. Alexander Firemen's Hall Rt. 98 & Rt. 20, Alexander, N. Y. (near Batavia). 80 tables inside, club display. Info: Dennis Sobotka, 4316 Military Rd. Niagara Falls, N. Y. 14305.

SEPTEMBER 23 - Binghamton, New York

1st Annual Bottle & Insulator Show & Sale, Masonic Temple, 66 Main St. Info: Chuck Purdy, 47 Dickinson Ave., Port Dick, N. Y. 13904.

SEPTEMBER 29-30 - Columbia City, Indiana

Hoosier Insulator Collector's Fall Show. Info: Paul Houpt, 211 S. Chauncey St., Columbia City, IN 46725.

NOVEMBER 4 - Springfield, Virginia

A show and swap meet will be held at the Springfield Mall. Info: James Barron, 6815 Darby Lane, Springfield, VA 22150.

---

INSULATOR CLUB FORMING...

Insulator Collectors Club-San Diego County has been formed with 25 and growing members. President Dennis Kotan, Vice President Maury Tasem, Treas. Edna Comstock. Club dues were set at single membership \$3.00 and family \$5.00 a year. We meet the 1st Wednesday of the month at Sears Community Room in El Cajon. Swap session from 6:30 to 7 pm and after meeting 'til 9:15. Business meeting at 7 pm. We selected the CD 200 California as our insignia. New members and visitors are welcome. We hope to grow locally to state wide.

---

---

1868 to 1869- Samuel Oakman was the treasurer of Massachusetts Glass Co. located in Boston on Medford St.

# FIRST PENNSYLVANIA INSULATOR SHOW

## JUNE 10, 1973

Show site at one of Pennsylvania's finest---The Embers Room of the Quality Inn and Embers Restaurant, Carlisle, PA. Call toll free for motel reservations (800-324-5131) or send for list of nearby motels or camping areas.

## CARLISLE, PA

Dealer set up time 6-8 a.m.  
Open to public 8 a.m. - 5 p.m.

Display tables free of charge, but limited amount available.  
Reservations needed by June 2.  
Refunds up to May 19.

Awards  
Door prizes  
Quality food  
Cocktail lounge  
Recreational facilities

Send payments to:

Edward Szymala  
J-137 Belmont Plaza Apts.  
Ross Road  
King of Prussia, PA 19406  
Phone (215) 265-6679

Admission, \$ .75  
Full table.. \$7.50  
Half table.. \$4.50

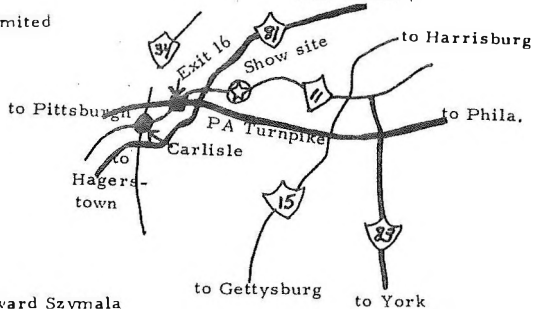

CD 121 U. S. Tel Co., aqua--\$10; CD 133 B. G. M., SCA \$30; CD 106 Duguesne (peak top), ice blue--\$18; CD 106 Duquesne, aqua--\$7; CD 263 Columbia, aqua--\$50; CD 143 no name, vertical ridges, base to dome, aqua--\$25. CD 168 D-510, amber--\$5. Ed & Jeannie Szymala, J-137 Belmont Plaza Apts., King of Prussia, Penna. 19406 (215) 265-6679.



# 2<sup>ND</sup> ANNUAL

## WEST COAST NATIONAL INSULATOR SHOW

BIG 3 DAY MEET

**September 1, 2, 3, 1973**

ALL NEW BAKERSFIELD ELKS LODGE HALL

**BAKERSFIELD, CALIFORNIA**

Sale Tables 8'-0"

3 Days \$ 25.00

2 Days \$ 20.00 - 1 Day \$ 12.50

Display Tables 3'-0" & 6'-0"

Limited Quantity

Free

**CROSS ARMS RIBBON AWARDED**

*Crown Jewels Ribbon and Trophies Awarded*

Floors Carpeted

Tables Covered

**FOOD, DRINK AND ROOMS AVAILABLE**

For Further Information and Reservations Contact

Chuck Henry

7400 Pembroke Ave.

Bakersfield, California, 93308

Ph. 805-399-8892

Orval Smith

814 Wilson Ave.

Oildale, California, 93308

Ph. 805-399-8487

OR

**BOTTLES WELCOME**

## SCHEMERS IN TELEGRAPH

1852.. A man from Brooklyn named Josiah L. Snow went to Canada and formed the Grand Trunk Telegraph Company (not connected with the railroad.)

Snow and Dwight were contractors with W. D. Snow as engineer. According to Josiah Snow the line cost \$250 per mile (probably closer to \$100.) After collecting their money, the Snows left Canada. The line limped along for several months but was disbanded with a loss of \$250,000 to investors.

1868... A charter was granted to H. B. and Sela Reeve, cousins of Mrs. Josiah Snow. Josiah Snow then in 1869 went on to Chicago to start the Great Western.

---

---

### ADDITIONAL PLEDGES TO KELLY "SLUSH" FUND

\$10... Tommy Middleton, P.O. Box 45, Hawthorne, FL 32640.

\$10... Claude R. Herdman, 1045 Edward Rd., Dunedin, FL 33528.

\$10... Joseph W. Dally, 17 Lake St., Monroe, NY

\$10... Jim Willert, R.R. #2, Rice Lake, WI.

\$10... Robery Maynard, 279 Forrest St., So. Weymouth, MA 02190.

\$15... James D. White, 431 Riverview, Logansport, IN 46947.

The total of the fund now stands at \$535.

## LETTERS TO THE EDITOR

Dear Sir:

My father was the inventor of the Scott C. Cutter porcelain tree insulators first made in green glass and patented in April 26, 1904. The glass insulator was manufactured by the Pittsburgh Glass Co. and has not been in production for 40 to 50 years. The porcelain insulator replaced the glass and this was made by R. Thomas Co. of East Liverpool, Ohio, and later in Lisbon, Ohio. The first ceramic insulator was without moisture ribs, the later had ribs. The insulators were sold in middle west and the eastern states. People wanted their trees protected from high voltage burning and the utilities trimming holes through the branches.

Max Gilbert Cutter  
170 Chicago Road  
Oswego, IL 60543  
Box 208

\* \* \* \* \*

Dear Max,

Thanks for the letter. We collectors always appreciate any information that helps us to learn the history of our insulators.

---

Dear Jim,

In regard to the letter from Tom Jones (April '73) your questions concerning the relationship between Knowles and Hemingray. I have just found the following CD 252.

Front: KNOWLES CABLE  
PAT. MAY 2nd 1893

Back: HEMINGRAY  
NO. 2 CABLE

Both front and back embossing is very strong. The ears on this insulator are very different from my Knowles #2 cable and my E. S. S. Co. No. 401, but kind of similar to the ones on my Hemingray 62. We will probably never know why this insulator has both names on it, unless someone comes up with a Knowles or Hemingray purchasing record. Also recently found two beautiful CD 162's:

Front: H. G. Co.  
PATENT MAY 2, 1893

Back: PETTICOAT

Both are in a nice medium purple-similar to CD 121 Am. Tel & Tel Co. in purple. Since this color for this insulator is not listed in Milholland's Book, wondered if anyone has any information on this insulator?

Marjorie Rider  
799 Cleveland Dr.  
Buffalo, NY 14225

\* \* \* \* \*

Thanks for the letter, Marjorie. Your find is helping to tie in Hemingray Glass Co. with Knowles. At this point the connection is very weak, but it is a lead.

As far as your CD 162 purple's are concerned, I don't have an answer for you. I'm sure if one of our readers can fill you in, they will be in touch.

---

Jim: Enclosed is a drawing of the N. E. Tel & Tel toll. (note CA Vol 1 No. 3, April '72, pg. 21.) The insulator from which this drawing was made belongs to Jerry Turner, Goshen, Ohio.

Glenn Drummond  
1287 Aldrich, Cincinnati, OH



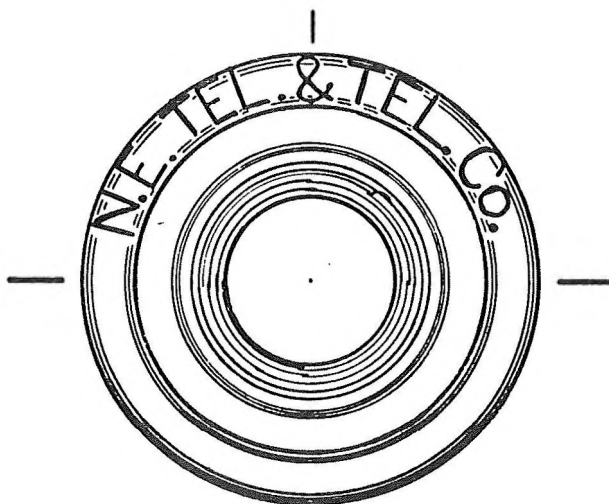
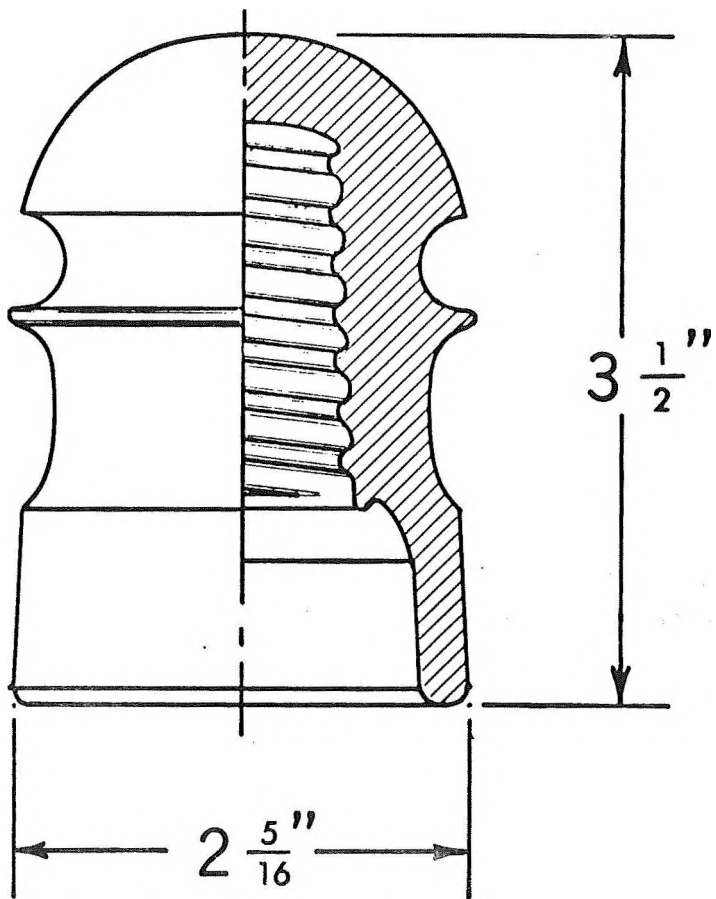

## PATENT INFORMATION

George Floyd, of Cincinnati, Ohio--Letters Patent No. 64,654, dated May 14, 1867.

Be it known that I have invented a new and useful insulator.

The object of this invention is a construction of glass-insulating bulb and its shank, which enables the ready renewal of the former when broken, or of its temporary removal and replacement for any purpose.

A is an axial section, and B a horizontal section, at the line XX of my glass insulator; D, a transverse section at the line YY of my shank, which shank may be of brass, steel, or iron, and be parted, D, at the top, and terminate in two similar tapering heads, EE' adapted for insertion up the axial aperture F of the insulator proper and having shoulders GG', adapted to engage over ledges HH', forming the bottom of the enlarged termination or chamber I of said aperture. The chamber I and bevelled head EE', being oblong in their transverse section, effectually prevent any rotation of the bulb upon its shank, and hold it firmly in position for the application of the telegraph wire, for which the customary groove J is provided. The aperture F flares or expands outwardly for the double purpose of facilitating the admission of the shank in the act of insertion, and of permitting of the application of a vise or pair of pincers to compress together the two heads EE' so as to enable the removal of a cracked or otherwise imperfect insulator.

I claim herein as new, and of my invention- The chambered insulator, provided with ledges HH', approached by a flaring aperture, F, in the described combination, with the two-parted and shouldered shank, the said shank and chamber being oblong in their horizontal section, all substantially as set forth.

G. FLOYD.  
INSULATOR.

No. 64,654.

Patented May 14, 1867.

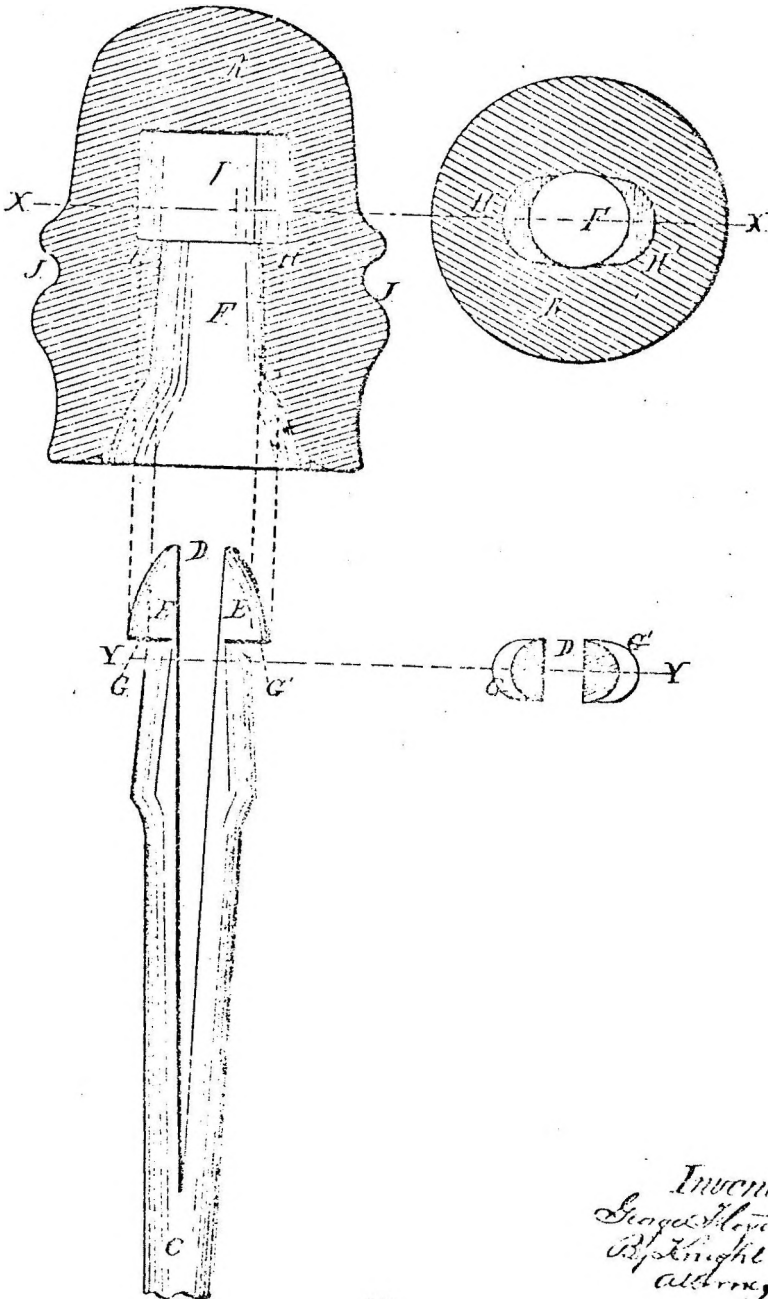

*Inventor:*  
*George Floyd*  
*R. Knight Bro.*  
*attorneys.*

## NEW FIND

Mr. Bill Teel of Toledo, Ohio displayed this insulator at the Toledo Show. It is 4" tall and 2 1/2" in diameter at the bottom of the skirt with no drips. It is embossed:

Johson and Watson  
Patd.

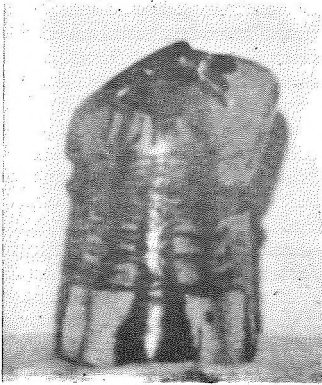

After several calls to knowledgeable collectors who attended the Toledo Show, I can say that this insulator is a modified version of a CD 409 "Harloe Claw." We are researching the name Johson and Watson--to date we have had no success.

---

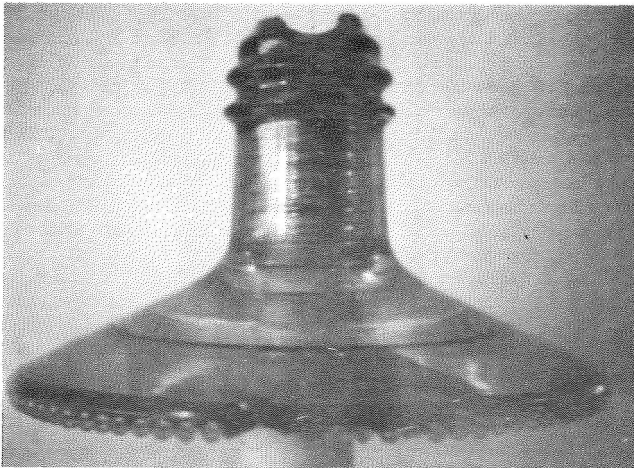

CD ???  
from Vern  
Russell of  
Gallion, OH



THE M. T. BOTTLE COLLECTORS SHOW  
by Bill Dreggors

The M. T. Bottle Collector Association of Volusia County, FL, held its 3rd annual bottle and insulator show at the county fairgrounds on March 31 & April 1. There were 70 tables and 52 dealers. Tables were divided about 50 for bottles and 20 insulators; so there was a large selection of glass that would please about any collector. Attendance was good on both days and trading and sales were brisk.

Gerald Brown's gift, his new porcelain book was won by Charles McCormick. CROSS ARMS 1st place was won by Bill Dreggors and 2nd place to L. L. Linscott after a flip of the coin broke a tie between him and Fred Griffin.

Many thanks to all the people who made this show a success by their hard work; especially Mrs. Gladys Peterson, chairman of the food committee.

There was many fine insulators exchanged. Some of which were a large pilgrim hat, flint Elliot, Lynchburg 181, Locke SCA, large Chambers and a couple of threadless.

We're looking forward to a bigger and better show next year so, "You all come, you hear!"

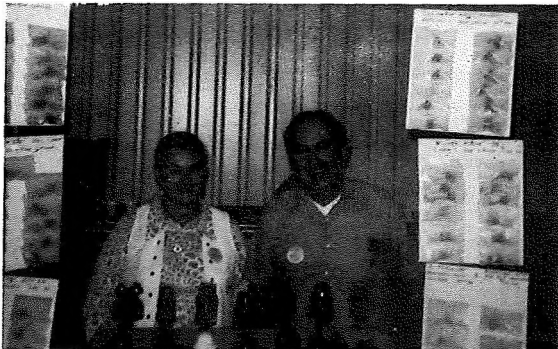

Jo & Bill Dreggors, winners of CROSS ARMS ribbon first place.

M. T. Bottle Show.



L. L. Linscott  
of Titusville,  
FL, winner  
of 2nd place  
CROSS ARMS  
Award.

Charles  
McCormick of  
Deland, FL  
winner of  
Gerald Brown's  
"Collectible  
Porcelain  
Insulators."



Fred  
Griffin and  
guest.

Marlin &  
Lars Glasgow  
of Ormand,  
Florida.



## GLASS CAPITOL SHOW

Report by Jack Snyder

The home of Libbey Glass, Owens, Illinois and Libbey Owens Ford was the site of the First Glass Capitol insulator show. on March 24 & 25. 28 dealers representing 8 states attended the two day affair. The log book had signatures of almost 400 collectors and curiosity seekers. The four judges were picked from the list of 28 dealers. They were: Janet Biggs (Northfield, Ohio), Al Studer (Toledo, Ohio), Russ Wagner (Marietta, Ohio), Ted Boughton (Corapolis, PA).

The OBX ribbon for showmanship went to Tim Askew from Brighton, Michigan. The "Crown Jewels" ribbon for best display went to Jerry Turner from Goshen, Ohio. The CROSS ARMS first place ribbon went to Paul Kelly from South Bend, Ind., for the best combination sales and display table, the second place CROSS ARMS ribbon went to the Sharers' from Des Moines, Iowa. Gerald Brown's porcelain book was given as a door prize and the winner was Coi Drummond from Cincinnati, Ohio.

Gary and I would like to thank everyone.

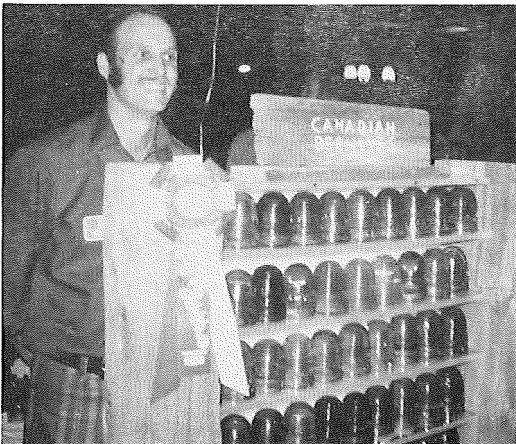

Tim Askew of Michigan winner of OBX ribbon.

Glass Capitol Show.

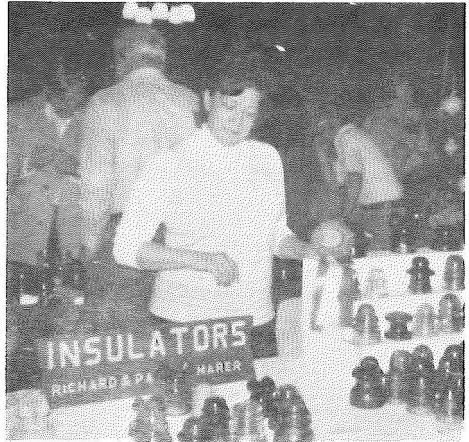

CROSS ARMS ribbon winners. Left-first place the Kellys of Indiana and right; 2nd place the Sharers of Iowa.



right: Crown Jewels winner, Jerry Turner of Ohio.  
left: Al Studer of Ohio, one of the show judges.



Membership now stands at 151 and all members should have received their directories. Be sure to tell any potential members about our club and the advantages to be gained through membership.

A site has been selected for our 1973 show and swap meet. The meet will be held in the Springfield Mall, Springfield, V.A., on Sunday, November 4. The mall is enclosed and there will be restaurants available. Admission will be free to members, 50¢ for guests. Member tables will be \$4, non-members, \$6. Half tables will be available for \$2.50.

The club has invited Mr. and Mrs. Milholland to attend and we hope they will be able to fit this date in their busy schedule.

This month brings the 129th anniversary of the beginning of electric communication. On May 24, 1844, Samuel Morse sent the message "What Hath God Wrought" from the chamber of the Supreme Court, which was located in the basement of the Capitol in Washington, D. C. Alfred Vail, a friend and associate of Morse, received the message in the Pratt Street Station of the B & O Railroad in Baltimore, MD.

Without this invention I wonder where we insulator collectors would be? Thanks, Mr. Morse, for creating the need for insulators!

With this column your club secretary, Peg Hotton, must with regret resign my position to become the first E. I. C. member in Illinois, where my family will be relocating in June. I hope to add many mid-westerners to the membership.

Bye!

**EASTERN  
INSULATOR  
CLUB**

Peg Hotton, Secretary

## THE WESTERN HALF OF THE TRANSCONTINENTAL TELEGRAPH

In 1853, after the reorganization of the California State Telegraph Company, the Alto Telegraph Company ran a wire from Sacramento to Nevada City and nearby mining towns.

1856, the Northern Telegraph Company built a line from Marysville to Treka. The line was constructed by J. E. Strong and I. M. Hubbard.

1858, the Placerville, Humbolt and Salt Lake Telegraph Company headed by Frederick Bee was organized. They intended to build a line across the Sierras and through the Humbolt Valley to the Great Salt Lake. By 1859, their wire reached Carson City and by 1860, the wire reached out to Virginia City and Fort Churchill. This is as far as the line could afford to build. Because of the construction running from tree to tree the line earned the nickname "Bees Grapevine."

The Placerville Humbolt Company asked the Federal Government for financial help to finish their project but they were turned down.

The "Grapevine" was a part of the Washoe Silver Mining days.

1860, the California State Telegraph Company absorbed the Alto Telegraph Company.

1860 (winter), J. H. Wade (an agent of the W. U. T. Co.) called a meeting in San Francisco to discuss a transcontinental telegraph. Three prominent names in attendance were:

I. M. Hubbard, superintendent of Northern Tel. Co.  
James Street, superintendent of Atlantic and Pacific Tel. Co.

Fred A. Bee, superintendent Placerville & Humbolt Tel. Co.

Three weeks later, all companies were merged together under the name California State Telegraph Company with a capital of \$1,250,000.

April 27, 1860, with the help of a federal grant, a company was formed under the name Overland Telegraph Company (most of the shares were purchased by California State Telegraph Company stockholders.)

James Gamble was general superintendent, I. M. Hubbard was superintendent of construction and James Street was general agent.

October 26, 1861, the East met the West at Salt Lake, Utah, and the Transcontinental Telegraph was a reality.

November 6, 1861, the Overland Telegraph Company was absorbed by the California State Telegraph Company. The company's capital at this time was \$2,500,000.

In 1867, the California State Telegraph Company was absorbed into the Western Union Telegraph Company.

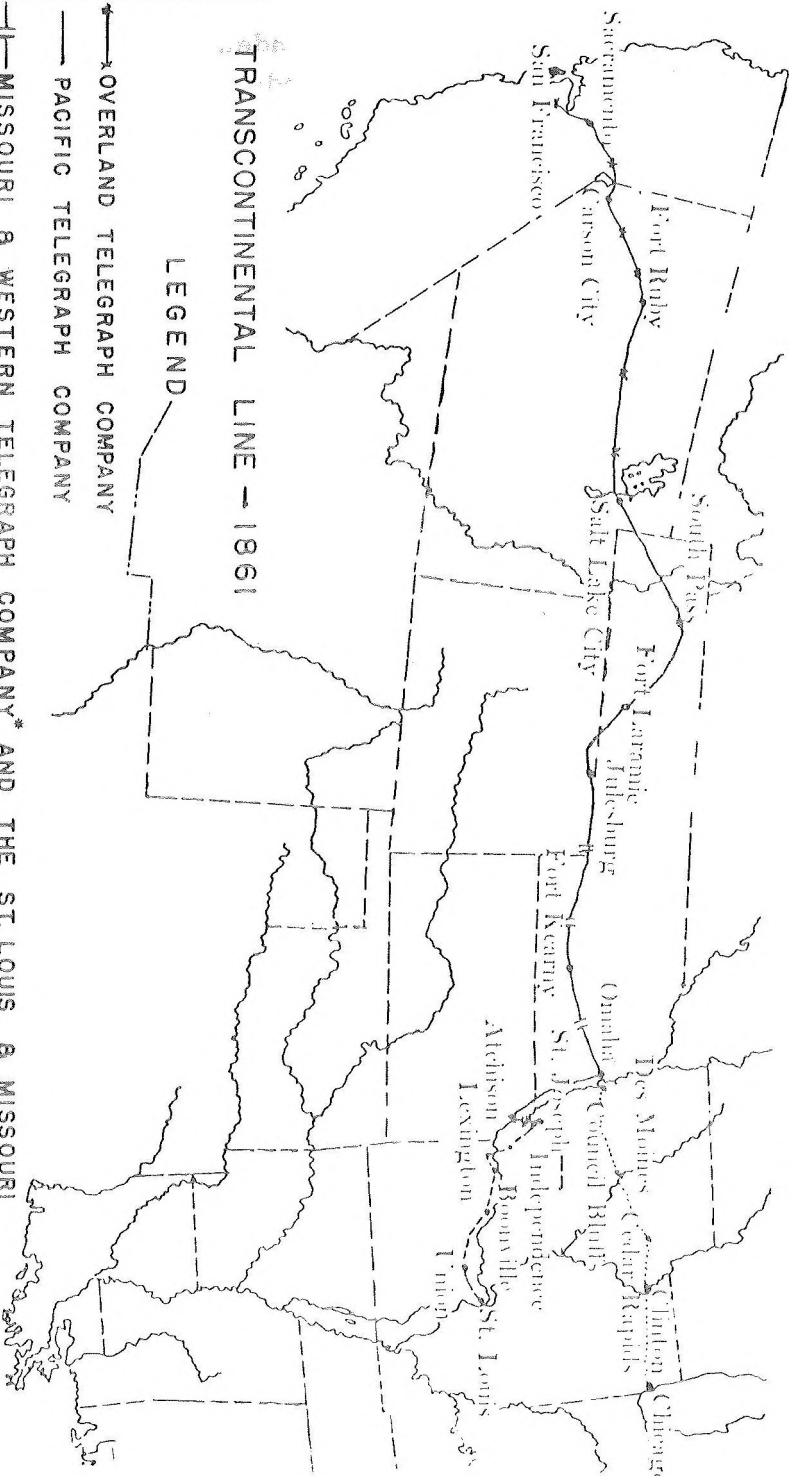

TRANSCONTINENTAL LINE - 1861

LEGEND

- >— OVERLAND TELEGRAPH COMPANY
- PACIFIC TELEGRAPH COMPANY
- - - MISSOURI & WESTERN TELEGRAPH COMPANY\* AND THE ST. LOUIS & MISSOURI RIVER TELEGRAPH CO. (ORIGINAL LINK OF THE TRANSCONTINENTAL LINE WITH THE EAST)
- ..... BRANCH OF ILLINOIS & MISSISSIPPI TELEGRAPH COMPANY (HASTILY BUILT FOLLOWING OUTBREAKS OF CIVIL WAR TO FREE TRANSCONTINENTAL LINE FROM WAR DISTURBANCES ENCOUNTERED ON SOUTHERN ROUTE)

\*.A.pppp



LIST OF EMBOSSINGS:

Front: McMICKING

Back. VICTORIA, B. C. 75 (small glass button under side of crown.)

No name. Smooth base. (this one has a flat top)



CD 734

CD 734 is a threadless telegraph insulator from Canada.

It is not known why the name McMicking is embossed on this insulator, but research does turn up the name in Canadian history.

Robert McMicking, born 1843, died 1915. During his lifetime, he held positions with Collins Overland Telegraph, Victoria & Esquemalt Telephone Company and B. C. Telephone Company.

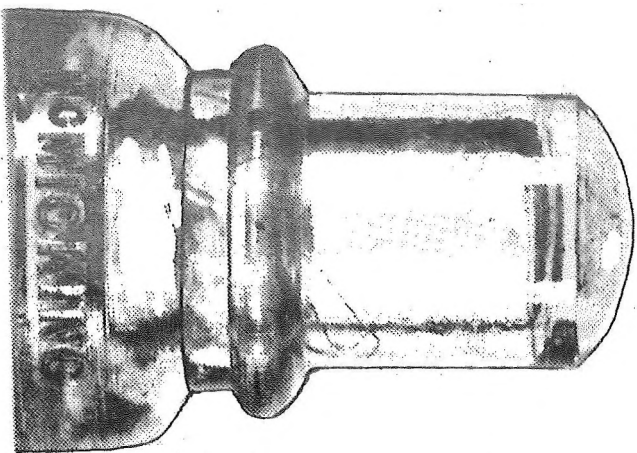

## MARKET NEWS

Beware of the cheaper styles of California's in yellow. Some were originally purple, but turn yellow after treatment.

---

Another fake that has been seen is a CD unembossed Mulford and Biddle threadless in apple green.

---

Going prices of insulators at the shows.

Manufacturer	CD	Condition	Color	Prices
--------------	----	-----------	-------	--------

### Woodbury, New Jersey Show

Whitall Tatum	155	mint	purple	\$35
Hemingray A/B	194/195	mint	purple	65
National	410	mint	aqua	295

### Ithaca Show

Hemingray	219	mint	amber	\$ 6
Manhattan	256	mint	aqua	12
Hemingray	175	mint	green	8
Whitall Tatum	529	mint	amber	25
California	160	mint	purple	10
Whitall Tatum	108	mint	SCA	7
Hemingray	168	mint	amber	7
Am Tel & Tel	460	mint	aqua	65
C. P. R. R.	143	mint	purple	8

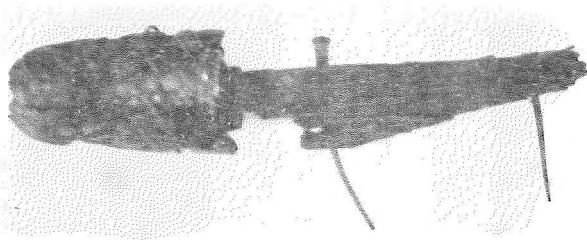

### THE MORMON WADE

This threadless dot and dash glass Wade insulator was found at Fort Casper, Wyoming. It was originally used at the North Platte River Crossing in the Wyoming Territory. This important crossing was a part of the Old Oregon Trail and was also known as the Mormon Crossing. This crossing was built by Brigham Young and the Mormons for their wagon trains going south to Salt Lake, Utah. It was also used as the route westward to the California goldfields in the 1840's to 1860's.

The United States Army's 11th Volunteer Cavalry was detailed to the Fort Casper area to protect this single strand telegraph line which was such a vital link to the west during this period in our history. They were also to protect the pioneer wagons from the marauding Sioux Indians who were still engaged in hostilities with the whiteman until about 1868. The wooden shield or cover was fashioned to protect the fragile glass insulator inside the Sioux's stone-tipped arrows.

The original pin is still intact even to the very old newspaper that was soaked in adhesive and wrapped around the pin to better secure the pin and insulator to each other. The old square nails are still intact and in place. One can, by gently removing a loose piece of the wooden cover, display the glass part of the Wade and there is still a small piece of canvas present that was used to act as a padding at the top of the insulator.

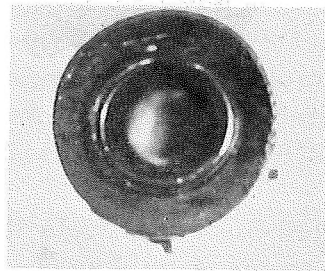
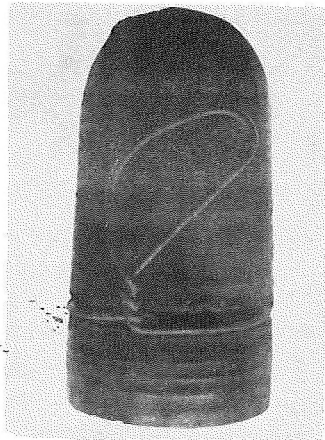
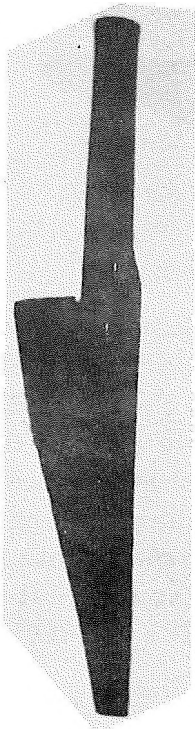

The three photos above show different views and the pin of another Wade insulator. This Wade wasn't dug it was found in a small Kansas Museum. The insulator and pin have never seen any use but they show exactly what a Wade looks like. Notice the outside wood covering, the included tie wire, and the glass cylinder inside the wood protector.

Neither history or research has uncovered the manufacturer of the Wade insulator. The only thing that can be said at this time is that the Wade type insulator was popular in the West, apparently because of its wood covering and because of the shortage of wire in the wilderness, the manufacturer furnished a tie wire with each insulator.

## HISTORY OF BLOCK RAMSHORN

In 1858, the Placerville, Humbolt, and the Salt Lake City Telegraph Company was organized. People of Carson Valley subscribed \$1,200,000 toward the project. Fred A. Bee was the manager and because wires were strung to trees, this line was called Bees Grapevine Line.

The Federal Government helped to build a line across Nevada to Salt Lake City in 1861. The project was divided in two from Carson City to Ruby Valley, Nev., and from Ruby Valley to Salt Lake City, Utah. It took less than 7 months for them to build the entire line.

The line replaced the Pony Express and operated in connection with the Overland Stage and Mail line through Central Nevada. When the Civil War broke out in 1861, Fort Churchill became a communications center in Western Nevada.

The telegraph and stage across Nevada were the only means of communications. For this reason overland mail coaches were guarded by dragoons, mounted infantry, the entire distance. When the first telegraph line was complete in 1861, the first territorial legislation was in session in Carson City, Nevada, and they sent the first through message to Washington, D. C., addressed to President Lincoln.

When the Central Pacific Railroad built its road across Nevada by the Humbolt Route in 1868-in 1869 its telegraph line along the right of way caused the first telegraph line across Nevada to be abandoned. Near by ranches cut the poles up for fence posts and strung

the wire from post to post.

The first telegraph pole was planted in Salt Lake City going west on July 10, 1861, on East Temple St. The first pole at Placerville, California, was set in 1858, for the Overland Telegraph to Genoa, Nevada, to Virginia City, Nevada, in 1859. This was financed with private money.

The Overland Telegraph was organized in 1860 and work started. Thirty wagons left Sacramento, California, with wire and insulators (wood block type ramshorns.) They had all provisions and several hundred head of oxen, horses and mules. Four months later the west was connected with Salt Lake City, Utah.

---

Our thanks to:

Bob Wilson of Philadelphia, PA for his pictures of the Wade insulators (both are from his collection) and the "Mormon History."

Mrs. G. M. Wheeler of Nevada, for her article on "History of the Block Ramshorn."

The artical "Western Half of the Transcontinental Telegraph" and the map are the efforts of several research trips by CROSS ARMS to the Philadelphia Free Library and the Franklin Institute.

## ITHACA SHOW

On April 14 & 15, some 70 collectors assembled at Ithaca, New York, High School to participate in the 2nd Annual Eastern National Show hosted by Brad and Nancy Cook of Ludlowville, New York.

There was a lot of good glass and porcelain at the tables. Most of the action was between dealers as the off-the-street trade was a little slow. Prices on intermediate glass were low and even a lot of good glass was priced low.

Jack Tod attended as part of his research trip and a lot of good porcelain was floating around. Here are pictures of the ribbon winners and some interesting close-ups.



**CROSS ARMS ribbon First Place to Mr. and Mrs. Chuck Barnes of Elmira, New York.**



Ithaca Show.

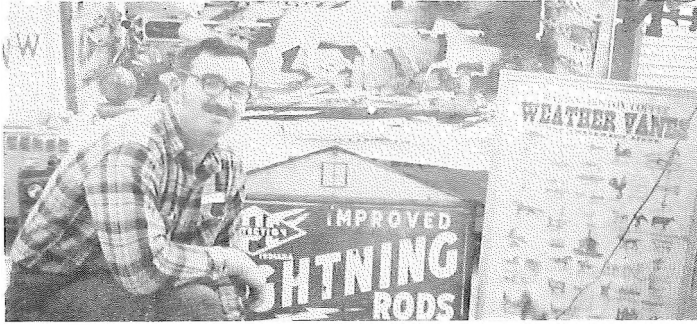

Second place CROSS ARMS ribbon winner, Jerry Turner of Goshen, Ohio.

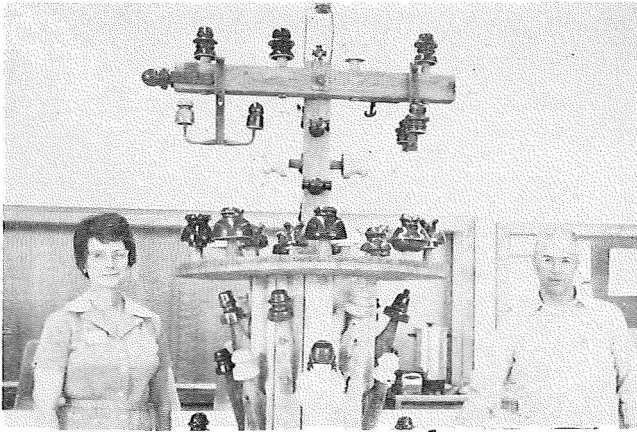

Mr. & Mrs.  
Edgar  
Smith  
Crown  
Jewels  
Grand  
Prize

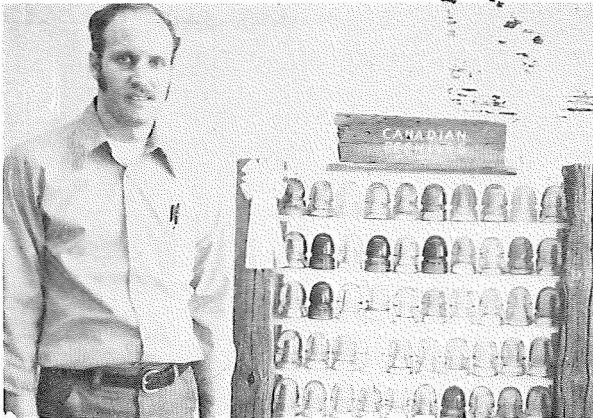

Tim Askew of  
Michigan  
Crown Jewels  
Third Place.

Ithaca Show.

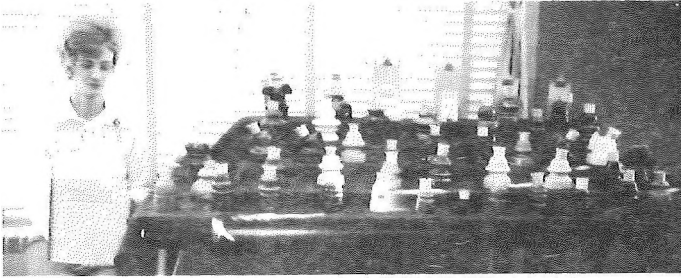

Ellie Dutcher of NY, winner of Gerald Brown's porcelain book.

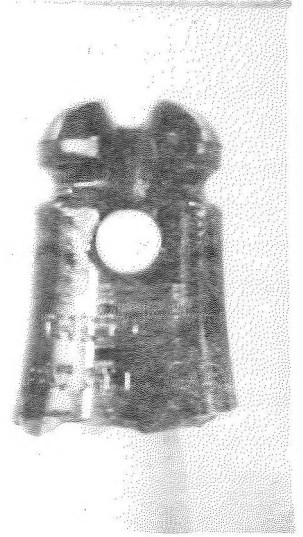

left: a new pin type porcelain 6 in. high, brown, extended inner skirt and embossed (on top of loop) JUNE 7, 1898 NY from John DeVolder, 1304 Countyline Rd., Webster, NY 14580.

right: the top 2/3 of a CD 268 embossed: THE CROWN, PAT ALLOWED found mounted upside down in a tunnel by Dave Fein of Summit, New Jersey.

## FRESNO, CALIFORNIA SHOW

by Addie Tasem

On March 24 & 25, Bill Heitkotter had his first insulator show. Every show has some problems but this one had its share. Bill arranged for the show to be held at the Town and Country Lodge in Fresno. They cancelled his show on 3-22 because they wanted, and booked the Hager Bros. in the same room. Bill signed his contract in Jan 73 and so the management found a very small loop hole and used it. The contract read "Sat. and Sun." hours "8 AM to 7 PM." You'd assume he had the room for 2 days but at 7 PM Sat. we had to be out! Bill explained the problem and everyone did their part to help fellow collectors move and set up again that Sunday. Bill and Madeline want everyone to be aware of such contracts as to prevent it from occurring to someone else. Even though everyone was upset over this, it just proves how great insulator people are in any circumstance.

The 43 tables were filled with the BEST display of glass yet to be seen this year! Prices were below book and in many cases - half! But no buyers were there to take advantage of it all! You, who live in the West, really missed the boat! Many dealers swapped glass and enjoyed meeting friends. Mr. and Mrs. Milholland of Washington, Mr. and Mrs. Don Harned of Chico (Crown Jewels' editors) and many other big insulator collectors and dealers were there. Where were you?



left: CD 168.5

right: CD 123

## Fresno Show.



Bill Heitkotter  
with Bob Thorpe  
and son, winners  
of the OBX  
ribbon for date  
nails.

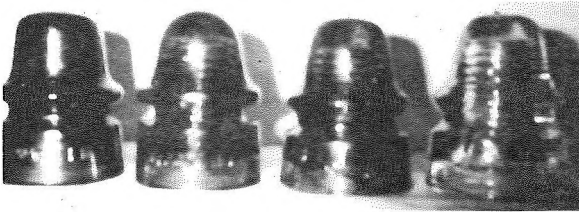

CD 162, four different ones. left to right: (A) large flat top dome (B) squared wire groove with straight skirt sides (C) flat base (not rounded like others) (D) large wire groove.



Ray Rehkop &  
Mark Hagen of  
Long Beach win-  
ners of Crown  
Jewels Award.

## CLASSIFIED ADS

WANT TO TRADE for the following transpositions:  
CD 190/91 single tops or bottoms all kinds except Hemingray; CD 200 Brookfield, Star with drips, no embossing; CD 201 Hemingray No 52, H. G. Co; CD 202 Knowles with drips, Brookfield No. 51; CD 203 Armstrong with 4 grooves; also different color variations. Complete description please. Harold Downing, Grant City, MO 64456.

---

FOR SALE, C. D. 165, Whitall Tatum Co. #5, \$7 MINT. Bob Maynard, 279 Forest St., So. Weymouth, Mass. 02190.

---

FOR SALE- \$1.50 each or 6 for \$8.00. Postage & insurance extra, excess refunded. The following CD numbers-CD 133 no name no. 20, aqua; 145 Star bullet top or tall slim, aqua; 145 N. E. G. M. (chip bottom) C. B. ; 252 Hemingray 62 cor. B. , clear; 128 pyrex, clear; 168 Hemingray D-510, clear, ice; 164 Maydwell 20 straw or off clear; 164 McLaughlin 20, l. green; 102 (diamond), aqua; 147 Hemingray or no name; 214 Hemingray 43, aqua or clear. Please give alternate numbers. All insulators V. N. M. to Mint. Walter Eriksen, 2118-50 Ave. N. E. , Puyallup, Washington, 98371.

---

FOR SALE: #2 Columbia, mint, \$150; #6 Westinghouse, lime green, mint, \$200; #25 Locke, n. m. , \$100. Chicago Diamond Grooves, n. m. , dome, \$40; n. m. , base, \$45, good condition, \$25; WANTED, E. C. & M's, Threadless. Postage and ins. paid. Large S. A. S. E. for list. J. E. Durham, 14110 S. E. 172nd Ave. , Clackamas, Oregon, 97015, Ph. 503-658-2409.

The Missouri Barbed Wire Collectors Association wishes to invite all insulator collectors to attend a 2 day swap, show, and sale June 2, 3, 1973 in Independence, Missouri. Displays desired as insulator ribbons and cash prizes will be awarded. Tables are 8 foot and only \$5.00 for both days. This show attracts collectors from throughout the Midwest area and draws a large walk-in crowd. Many hotels and motels in the area as well as camping grounds next to the show. For further information contact either Piper Wrigley, 2404 Harvard, Independence, MO 64052 or Marie K. Gordon, 411 E. Kansas, Independence, MO 64050.

#### COLLECTING THREADLESS AND RAMSHORNS.

I have been bitten by the threadless bug. Will break up my 900 piece threaded collection for threadless, ramshorns or cash. Want all threadless, embossed or unembossed, mint to damaged. Repaired threadless accepted. Collectors always welcome. Bob Wilson, 12612 Chilton Rd., Phila. PA 19154 (215) NE 7-9435.

---

HAPPY BIRTHDAY, ADDIE, love, Maury, David, Michael and Scott.

---

FOR TRADE PRR, Gaynor, Locke, Whitall Tatum, Brookfield, Hemingray. Looking for common insulators. All letters answered. John Bogan, 2 Leroy Avenue, Berlin, N.J. 08009.

\*\*\*\*\*

SW AP	SHOW	SELL
-------	------	------

INSULATORS - BARB WIRE - RELATED ITEMS

Ft. Scott, Kans. Fairgrounds-22nd & Horton St.

Sponsored by Bourbon Co. Insulator & Barb Wire Club

JUNE 9 - 9 AM to 8 PM                    JUNE 10 - 9 AM to 7 PM

Tables:	1 day \$4.00	8 foot tables
	2 days \$7.00	set-up Friday after 6 PM

Free admission - parking - lunch served in building

Contact:	Paul Schrodter	Edna Wood
	912 S. Margrave	RFD #1 Box 8
	Ft. Scott, KS 66701	Ft. Scott, KS 66701
	(316) 223-0371	(316) 223-3980

CROSS ARMS & "Crown Jewels" ribbons awarded.

\*\*\*\*\*

The following are for sale to support my threadless collection:

CD 127	W-1 on dome, black glass, NM	\$140
CD 127	H. Brooke, crude	65
CD 130	Ca. Elec Wks, pale aqua, w. g. chip	55
CD 433	unemb. purple-couple dings & sk. chips	25
CD 1001	Cutter, green, very nice condition	110
CD 416	"B", early trans., bruise on skirt	75
CD 131	Tillotson & Co. N. Y. on dome, Brookes pat. on skirt-dome has been reglued	65
CD 410	National corkscrew	95
CD 459	Boston Bottle Works, barrel types couple chips	140
CD 458	Boston Bottle Works, screwtop, has skirt damage	325
CD 181	Pluto ears, rim ch & mold flaw	625
CD 263	Pat. June 17, 1890, pale blue Columbia	150
CD 254	Hemingray 63, ice color	85

Russell R. Sprague, 8800 Green Lane, Randallstown, MD, 21133.



FOR SALE - GLASS INSULATORS: PRIVATE ISSUE  
 No 2 / Columbia / LSV (Milholland New Book page  
 181 CD 262) NOW Available in COBALT BLUE AND  
 GREEN GLASS. Mint @ 20.00 each VNM @ 15.00  
 each plus 1.00 post. NEW Milholland REVISED Book  
 AND Price list a 10.00.

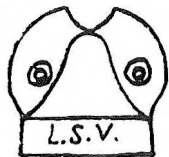

VENEZIANO  
 324 Hawthorne  
 Bensenville, Ill 60106



CD 272 No name, medium aqua, several NM-VNM  
 \$15.00; base chip/side bubble break \$12.00; base bruise  
 w/wg chip \$8.00; cloudy NM \$8.00; interior bruise  
 \$5.00; CD 138 National, minor chipping around pin hole  
 NM \$50.00; CD 205 Gayner-530 NM \$10.00; CD 102  
 Brookfield clear VNM \$5.00; CD 261 Cable threads on  
 skirt VNM \$25.00; CD 134 G. E. Co. MLOD base chip  
 minor dings \$5.00. Postage \$1.00 each. Pete Schriber,  
 321 Toftrees #231, State College, PA 16801.

Gerald Brown's "SECOND EDITION"  
 of "COLLECTABLE PORCELAIN INSULATORS"

Not a supplement.

A COMPLETE guide for porcelain insulator collectors.

175 pages 8 1/2" x 11" Plastic ring binding

Pictures and drawings describe over 700 porcelain insulators.

\$6.00 P.P.)

From Author Gerald Brown  
 Two Buttes, Co. 81084

For Sale: only- CD 254 No. 3 CABLE, smooth  
 base. \$25.00 each; \$125.00 for 6. R. D. Wing,  
 28439 Rosslyn, Garden City, MI 48135 (313)-4211067.

CD 124 Hemingray No. 4, aqua, NM \$4, M \$6; CD 113 Whitall-Tatum No 13, straw, M \$7; CD 263 Columbia VNM \$50- M \$55; CD 162 H. G. Co, amber, no drips, M \$75; CD 107 Birmingham, straw, M \$25; CD 122 Hemingray 16 bright 7-up green, M \$5; CD 433, Hemingray #3, aqua, NM \$5- M \$9; CD 151 H. G. Co. N. A. T. Co., aqua, NM \$6; CD 257 Hemingray 60 clear, M \$3; CD 154 Whitall-Tatum #1 S. C. A., M \$4; CD 712 Hemingray 518, clear, M \$3. Plus postage on orders under \$25. Paul McManis, Route 1, Box 116, Excelsior, Minn. 55331, (612) 474-3541.

---

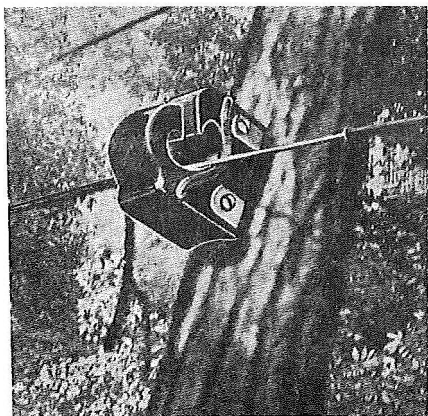

SCOTT C. CUTTER  
PORCELAIN TREE  
INSULATORS. Embossed with name and dates--made in power and telephone sizes. Limited number available in mint condition, including holders and drive screws for power size only. \$35.00 PP

M. G. Cutter, Box 208, Oswego, Ill 60543.

---

Cash for rare insulators. Unusual shapes and colors, threadless, cobalt, etc. Paul Kelly, 401 National Bank Bldg., South Bend, Ind. 46601.

---

Will trade insulators for brass railroad locks, or any padlock embossed Winchester or Keen Kutter. Dave Fullmer, 18148 Gresham Northridge, Calif. 91324.

---

Specialty collector needs better and unusual CD 160 and Amer. Ins. Co. Jerry Wagner, 15 N. Demarest Ave., Bergenfield, N.J. 07621.

FOR SALE OR TRADE FOR RARE OR THREADLESS

CD 436 ERW mint (blue)	\$275
CD 437 Winged Chambers, minor wind dam.	315
CD 701 Egg, aqua, rare, wire groove dam.	125
Mine threadless, green, nm	50
CD 731 Unembossed McKee, aqua, mint	90
CD 735 Mulford & Biddle, without UPRR, aqua	
1 stress crack	120
CD 735 Mulford & Biddle, UPRR, cobalt sm.	
ridge chips	190
CD 735 Mulford & Biddle, green, ch removes	
part of UPRR	55
CD 127 W 1 on dome, aqua, mint	90
CD 104 Agee, royal purple, mint	25
Porcelain Gutter, mint	30

William P. Cosner, Box A, New Hope, PA 18938  
 (215) 862-2039.

CD 416 B VNM	\$100
CD 457 Standard vvm+	75
CD 143 Canadian Pacific vertical & hori- zontal ridges-normal ridge flaking	50
CD 185 Mine Insulator-flat rim chip	35
CD 263 Columbia Pat'd May 12, 1891 (cpl. chs)	40
CD 456 Am Ins Co	25
CD 157 Brookfield	17
CD 143 Montreal Tel. Co. couple bs. chips	20
CD 200 Star-lg shoulder ch on rear, displays very well	25
CD 134 T-H. E. Co.	8
CD 134 G. E. Co.	7

Will consider any trades - looking for good color.

Postage & insurance extra. Doug MacGillvary, 51

Avondale Rd., Manchester, CT 06040 (203)649-0477

Insulator-bumper stickers-beautiful blue, feature No 4 Cable, painted on long lasting vinyl material with peel off backing. Only 50¢ each or three for \$1.00 plus large SASE. Robert Gilbert, 245 Coldstream, Frankfort, KY

SEPT. 23, 1973, Southern Tier Bottle & Insulator Collector's Assoc. presents 1st Annual Bottle & Insulator Show & Sale, Masonic Temple, 66 Main St., Binghamton, N. Y. 50 tables 8' X 30" available a \$10.00 each. Refreshments. Info: Chuck Purdy, 47 Dickinson Ave., Port Dick., Bing., N. Y. 13904, phone: 607-7237096.

Huge list of insulators and lightning rod balls for sale. SASE Paul McManis, (CA) Route 1, Box 116, Excelsior, MINN. 55331.

CALIFORNIA'S FOR SALE: CD 162, yellow, \$27.00, CD 133, green, \$15.00, CD 259, sage, \$30.00; CD 152, SCA, \$5.00, green, \$8, sage \$4.00, aqua, \$10.00, CD 162, aqua \$10.00, CD 160, smoke \$6.00, green, \$8.00 CD 164, no name, sage, \$22.00. Please add \$1.00 for postage per insulator, balance returned. G. Hill, 1949 Marlow Rd. Toledo, Ohio 43613.

PORCELAIN INSULATORS GUIDE BOOK FOR COLLECTORS, a comprehensive original research book and complete collector's reference for unipart pin type porcelains. Universal Style Chart with scale drawings of every unipart pin type shape, manufacturer's markings, pricing guide, company histories, etc. The standard for collectors and mail traders. Hardbound, 206 pages, \$10 postpaid. Also 1972 Supplement, \$1.95 postpaid. Jack H. Tod CA, 3427 N. 47th Place, Phoenix, Arizona, 85018.

SECOND ANNUAL SOUTH CENTRAL NATIONAL  
INSULATOR SHOW & RELATED COLLECTIBLES

CATALINA MOTOR INN, FRANKFORT, KY

Fri. June 1st	6 PM- 10 PM
Sat. June 2nd	8 AM- 6 PM
Sun. June 3rd	8 AM- 6 PM

Tables 6' X 30". Covers provided. Prices per table:  
Reservations received by May 31st: Fri., Sat. &  
Sun. - \$13.00 or one day \$7.00. After May 31st: \$15.00  
each or \$8.00 one day.

Plenty of free parking & excellent unloading space.  
Air conditioned space - Security Guard Fri. & Sat.  
night. Food & lodging available at location and  
Map & lodging information on request.

CROSS ARMS and Crown Jewels ribbons awarded

Mail reservations to:

Wayne A. Moore  
124 Meredith Ave.  
Frankfort, KY 40601  
Ph. 1-502-875-3352

or

Robert W. Gilbert  
245 Coldstream Dr.  
Frankfort, KY 40601  
Ph. 1-502-227-7210

INSULATOR BOOKS POSTPAID ! MILHOLLAND'S  
MOST ABOUT GLASS INSULATORS, 2000 PRICED,  
250 PAGES, HARD COVER \$10.00. WOODWARD'S  
REPORT CD NUMBERS AND HISTORY \$4.25.  
KNOWLES 1902 CATALOGUE REPRINT 50 PAGES  
\$3.00. LOCKE REPRINT 64 PAGES \$3.00. ABOVE  
PAIR \$5.00. TOD'S PORCELAIN INSULATORS 203  
PAGES, PRICING FORMULA, HARD COVER \$10.00.  
MILHOLLAND'S BOOK "TWO" PRICES 1000 INSULA  
TORS \$4.50. DELLING BEFORE THREADS \$3.00  
STUART'S INSULATOR GUIDE, SOME COLOR  
PICTURES, PRICES \$4.95. Peters Books, 1240  
West Kearney, Fresno, California 93706.

## ATTENTION

Dear Collector:

The process of acquiring a large general insulator collection, (which contains many smaller specialized ones,) has been accomplished in about six years and selected from hundred of insulators.

Donations of collections to several museums, including the Smithsonian, Pawnee-Plains and Dickinson County (Abilene, Ka.) has failed to reduce my collection to a manageable size. I would also trade glass for porcelain he can fill in his collection. Another factor is the fire hazard in Two Buttes. I am forced to keep a portion of the collection in fire proof storage in another town (fifty miles round trip)

Selling insulators that collectors need for specialized collections seems to be the logical solution. The C.D. numbers and color variations are quite complete. The values run from the common to the rare (both threaded and threadless) I will sell most any insulator in my collection, (some few exceptions) until the numbers are reduced for better displaying with adequate lightning effects.

Questions will be answered and special lists made up on request.

Two Buttes, Cal. 81084

Sincerely  
E. A. Brown

1st ANNUAL SOUTHERN NEW JERSEY  
INSULATOR SHOW

sponsored by Gene Bond

Saturday May 26 Moorestown High School 10 am-4  
Moorestown, N.J.

Adults \$.75 children (under 8) free

Maps & more information contact:

Gene Bond 609-234-3926

15 East Camden Ave. Moorestown, N.J. 08057

FOR SALE: dark green-CD 152 Brookfields \$5.00-  
mint, n-mint, \$4.00. Also porcelain Locke 9 (emb.)  
\$10.00, CD 147 Spiral groove dated green-\$6.00,  
CD 147 Spiral groove, Hem. dated, aqua, \$10.00.  
Gerald F. Johnston, 4829 E. Sanilac Rd., Kingston,  
Mich. 48741.

EL PASO CENTENNIAL COLLECTORS SHOW

Bottles Insulators Historical & Frontier Artifacts

in conjunction with nationally advertised

ANIVERSARIO DEL PASO '73

Sat. May 12: 8 AM-8 PM

Sun. May 13: 8 AM-6 PM

National Guard Armory

Security Guard Furnished

75 Tables

\$7.50 one day

\$15.00 two days

Bob Keyes 1032 Burgess El Paso, Texas 79907

Tel. (915) 598-3212

Paying top cash prices for Insulators I need--need  
rarer types or quantities of color. CD 320 171 carnival  
mint \$32.00, D-518 amber spools \$12.50 mint.  
L. Veneziano, 8310 Center, Rivergrove, IL 60171.



**JUMBO  
SHOW**

**2ND**

**JUMBO  
SHOW**

# CHICAGO MID-WEST NATIONAL INSULATOR SHOW

**KANE COUNTY FAIRGROUNDS**

**Oct. 12 - 13 - 14**

**FREE FRIDAY - "Wheeler - Dealer" Day**

**Dick Augustyn**



**Larry Veneziano**

**Acres of Parking**  
**200 plus Tables**  
**Super Large Bldg.**  
**Dealer Collector**  
**Display Tables**  
**Show Ribbons**  
**Awards**  
**Food Served**

**Admission to FairGrounds**  
**\$1.00 Each**

**No Additional Admission**  
**Inside - Or - Outside**

**Display Tables Welcomed**

**A SPECIAL FEATURE:**  
**LIGHTNING ROD BALLS**  
**WEATHER VANES AND ARROWS**

**BOTTLES WELCOME**

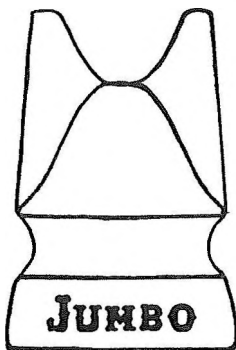

**SHOW**

**FAIRGROUNDS**

**(on Randall Rd.)**

**Thru ST. Charles On Rt. 64**

**St. Charles, ILL.**

**JUMBO SHOW**  
**Time**

**8 a. m. TO 6 p. m.**

**200 plus Tables**  
**Acres of Parking**

**FREE FRIDAY**  
**Wheeler - Dealer " Day**

1 - TABLE	1 - DAY	\$ 12.00
1 - TABLE	2 - DAYS	\$ 20.00
2 - TABLES	2 - DAYS	\$ 30.00
3 - TABLES	2 - DAYS	\$ 45.00

**(BOOTH)**

**For Reservations:**

**Veneziano**  
**324 Hawthorne Dr.**

**Bensenville, Ill. 60106**

**Phone (312) 766-3705**

"Advanced glass insulator collection for sale to highest bidder over \$1,200. From unlisted, to rare ones to common. Contact Mr. or Mrs. Nelson Lightcap, R. D. R. D. #1, Box 129, Nanty-Glo, PA 15943. Phone 814-749-0987.

**MOST ABOUT GLASS INSULATORS—REVISED**

**By Milholland**

2000 Glass Insulators described in complete detail. Hundreds of full size photos and machine drawings listed with Consolidated Design numbers for pin type and threadless insulators. Historical information of real interest. Complete production record of many insulators. Stories by the top authorities in the Telephone and insulator world. This 264-page hard cover book together with the 1973 suggested price list \$10.00 Post Paid.

**ALSO**

**THE FAVORITE MILHOLLANDS No. 2 BOOK**

Milhollands Glass Insulator Reference Book No. 2—Nearly 700 insulators described. Full size photos and machine drawings. Paper back book. Complete with 1973 Suggested Price List. For the beginner a must. \$4.50 post paid.

1973 Suggested Price List, separate, \$1.50 post paid.

These books from your dealer or order direct.

**Marion Milholland, Rt. 2, Box 368  
Sequim, Wash. 98382**

---

Pyrex 453 carnival CD 326 mint & beautiful condition, \$38.00 each postpaid. And assortment of 12 cobalt & blue porcelain insulators, \$27.00 postpaid. Jumbo with ears CD 269, \$135.00. Hemi #60 Mickey Mouse clear mint \$50.00 per dozen plus postage. R. D. Wing, 28439 Rosslyn, Garden City, MI 48135. (313) 4211067.

---

New England Tel & Tel, CD 104. Near mint-mint 1.75. Good-fine 1.00. Special; 10 different insulators for 7.50. Prices plus postage, satisfaction guaranteed. Small list of low priced insulators available. Octagon House Rt. 2-C Litchfield, Maine 04350.

	SELL	OR	TRADE	
CD 252	Gayner 620, mint	\$55	NM	\$35
CD 254	#3 Cable, mint			25
CD 259	Cable, chips \$4, NM \$8, mint			10
CD 461	Standard Glass Co., NM			90
CD 735	Mulford & Biddle, dark blue, VNM			185
CD 261	Cable, mint			20
CD 263	Columbia, mint			50
	2 piece Muncie w/pin, mint (post. ex.)			50
CD 260	Dated Star Helmet, VNM			100
CD 254	Hemingray #3 Cable, mint			35
Satisfaction guaranteed. Jerry Wagner, 15 N. Demarest Ave., Bergenfield, NJ 07621.				

For Sale-(CD 145) in mint to near mint condition. G. T. P. aqua, ice blue-\$10.00; G. T. P. Tel Co aqua, ice blue-\$11.00; G. T. P. /B emerald green-\$25; T. C. R. aqua-\$12; E. D. R. aqua-\$60; Brookfield 44 emerald green-\$25; C. P. R. porcelain-\$7; Gisborne porcelain-\$12; 1678 aqua-\$15; CD 102 Diamond in purple, amber, olive. CD 190 and CD 191 Diamond royal purple, aqua. Brookfields in green. Peter Nakonechny, Ruthilda, Sask, Canada.

---

102	So. Mass Tel Co	aqua	\$90 M
103	B	aqua	16 M
102.3	Bar F/B	aqua	35 VNM
124	Bar F - Crescent B	aqua	30 M
133	Homer Brookes etc.	milky blue	50 VNM
133	H. G. Co No 7 Standard	cornflower	20 VNM
187	Bar Front	aqua	17 M
196	H. G. Co etc	dark aqua	25 VVNM
241	Hemingray No. 24 (sdp scarce)		40 M
157.5	Standard Glass etc.	ice	100 NM

For Sale or Trade. J. R. Snyder, 244 Waggoner Blvd., Toledo, Ohio 43612 (419) 476-4902.

---

6. In order to keep CROSS ARMS up to date we would like all reports on shows and swaps sent in no later than 45 days after the show has taken place.

ADVERTISING RATES:

DISPLAY ADS:

1/4 page - \$5.00 per issue  
\* \$12.00 per three issues

1/2 page - \$10.00 per issue  
\* \$25.00 per three issues

Full page - \$18.00 per issue  
\* \$45.00 per three issues

\$.05 per word (minimum \$1.00). The closing date for material will be the 15th of the month preceding the month of the issue.

Ads received too late for the deadline will be run in the next issue.

CROSS ARMS encourages want ads that list the value of the insulators advertized so any ad listing 10 or more insulators with prices will receive an additional one month's free exposure.

J. R. DOUGHERTY  
PRINTING SERVICE

300 PROSPECT AVE., BRIDGEPORT, PA. 19405

Telephone: 272-7394



**CROSS  
ARMS**

367 Signal Hill Road  
King of Prussia, Pa.  
19406

RETURN POSTAGE GUARANTEED

JOHN R. SNYDER  
244 WAGGONER  
TOLEDO, OH 43612

**FIRST CLASS MAIL**

